

# **IQTouch**

## **Interactive Flat Panel Display**

### **TE1100 Pro**

——User Manual——



Returnstar Interactive Technology Group Co., Ltd.

# Content

Safety Instruction .....	1
1.Installation .....	2
1.1 Bearing .....	2
1.2 OPS Installation .....	5
2.Enable the Device .....	6
3.Control Panel .....	7
4.Interface .....	7
5.Remote Control .....	8
6.Remote Control Area .....	8
7.Connecting and Setting .....	10
7.1 External Computer and Touch Connecting .....	10
7.2 AV Connecting .....	11
7.3 Video-OUT .....	12
7.4 RS232 .....	13
8.Android Home Page .....	15
8.1 Floating Menu .....	16
8.2 Sidebar .....	16
9.Android Settings .....	22
9.1 Individualization .....	25
9.2 Network .....	24
9.3 Intelligence .....	26
9.4 System .....	28
10.Whiteboard App .....	31
10.1 Interface display .....	31
10.2 Menus .....	32
10.3 Aid tools .....	37
10.4 Scan code sharing .....	38
10.5 Common function .....	40
11.Screen Share .....	48
11.1 Application note .....	48
11.2 Operating instructions .....	48
11.3 Special instructions for multi-screen interactive interface .....	48
11.4 Webcast remote screen sharing .....	51

11.5 Laptop screen sharing .....	51
12.Built-in PC Operation .....	53
13.Troubleshooting .....	54

## Safety Instruction

For your safety, please read the following instruction before you use the product. Serious injury or property loss may be caused by improper operations. Do not try to repair the product without guidance.

### Placement

- Do not place the unit on an unstable cart, stand, tripod, racket, table, or shelf.
- Do not expose the unit to direct sunlight and other sources of heat.
- Do not handle liquids near or on the unit.
- Never spill liquid of any kind into the unit
- Do not put the unit near appliances that create magnetic fields.

### Power Supply

- Check that the unit's operating voltage is identical with your local power supply.
- Please unplug power supply and aerial plug when the weather is thunder-storm or lighting.
- Please unplug power supply when there is nobody at home or didn't use over a long time.
- Please keep power cord from physical or mechanical damage.
- Please use exclusive power cord, don't modify or lengthen it.
- Please check and ensure AC source is connected with the ground.
- A sudden power failure may damage the panel.
- Frequent power on and off in a short time may cause faults.

### LED Screen

- Never use any other tough or sharp object to replace the written pen.
- Unplug the power supply plug before cleaning.
- Clean the screen with a soft dustless and dry cloth.
- Never use water or the spray type detergent to clean the unit.
- For deep clean, contact an authorized service center.
- Please don't display the high brightness image on the screen for a long time.

### Sight Distance

- The best distance between audience and screen is 5-7 times that of screen diagonal.
- The best watching angle between audience and screen is within  $176^\circ$

### Temperature

- Do not place the unit near or over a radiator or a heater register.
- If your unit is suddenly moved from a cold to a warm place, unplug the power cord for at least.
- Two hours so that moisture that may have formed inside the unit can dry completely.

- Normal operating temperature is 0 ~ 40°C.

### **Humidity**

- Do not expose machine in rain, damp or place near water.
- Ensure the indoor drying, cool.

### **Ventilation**

- Keep the ventilation openings clear.
- Ensure that the unit has enough space for ventilation around: left, right and back >10cm, top>20cm.

### **Earphone**

- It will affect the hearing if you listen to noisy sound for a long time.
- Before using earphone, please turn down the volume in advance.

## **1.Installation**

### **1.1 Bearing Capacity**

If the product is installed in a wall-mounted way, the bearing capacity of the surface for installation must be at least four times of the weight of the product. If the surface for installation is a wall or the ceiling of a building, the surface must be made of solid bricks, concrete or other materials with equal intensity. If the product is installed on a surface made of loose material such as an old brick wall, wood plank wall, solid brick wall, a metal or non-metal structure surface, or a surface with a thick decoration layer, take necessary consolidating measures to ensure that the product is stably installed.

### **Step1: Punching holes in the wall**

Mark 8 holes location on the wall according to wall mounting bracket A and use the drill bit drilling the 8 holes. Depth of holes not less than 90mm (Ref. Picture 1)

#### **Note:**

In order to ventilate and dissipate heat to ensure the normal operation of the device, please keep enough distance between the device and other objects. It is recommended that the top and bottom are more than 20cm away from the mounting surface, and the left and right sides, the rear are more than 10cm away from the mounting surface.

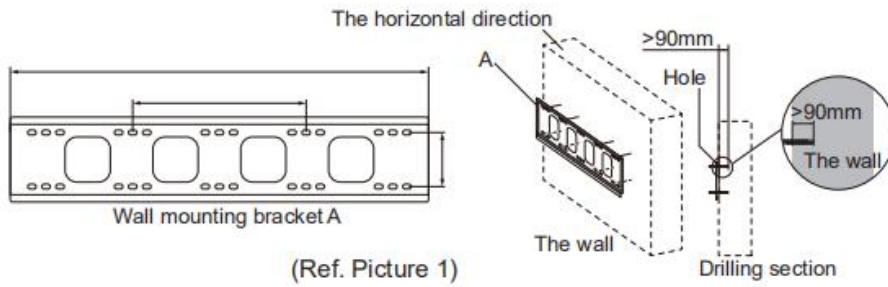

(Ref. Picture 1)

## Step2: Expansion bolt installation

Press the expansion bolt into 8 holes. (Ref. Picture 2)

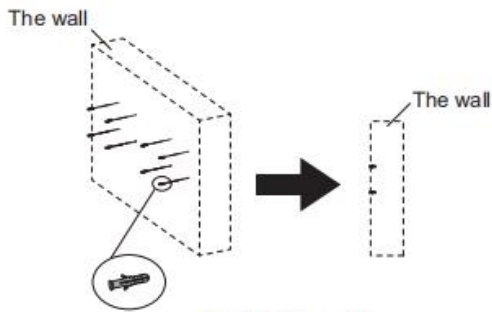

(Ref. Picture 2)

## Step3: Wall mounting bracket A installation

Install the wall mounting bracket A with 8pcs screws and gaskets. Please ensure that the wall mounting bracket A is installed horizontally. (Ref. Picture3)

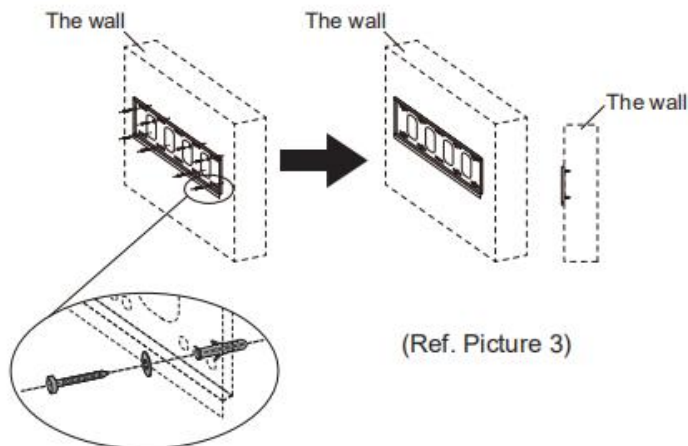

(Ref. Picture 3)

## Step4: Install the left& right hang bracket B to IQTouch.

Use screws fix the hang bracket B at the back of IQTouch. Please check the direction of hang bracket B before installation. (Ref. Picture 4)

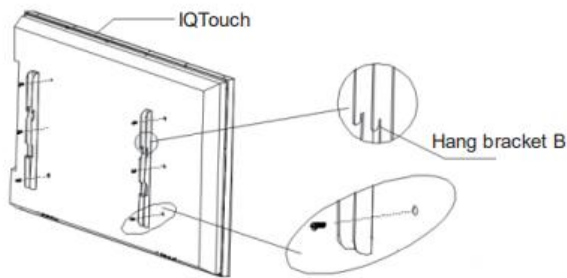

(Ref. Picture 4)

### Step5: Hang IQTouch on the wall mounting bracket A

Hanging the left &right hang bracket B to the wall mounting bracket A, please ensure two hang brackets B total hang on wall mounting bracket A, then tighten the screws of hang bracket B to prevent it slide. (Ref. Picture5)

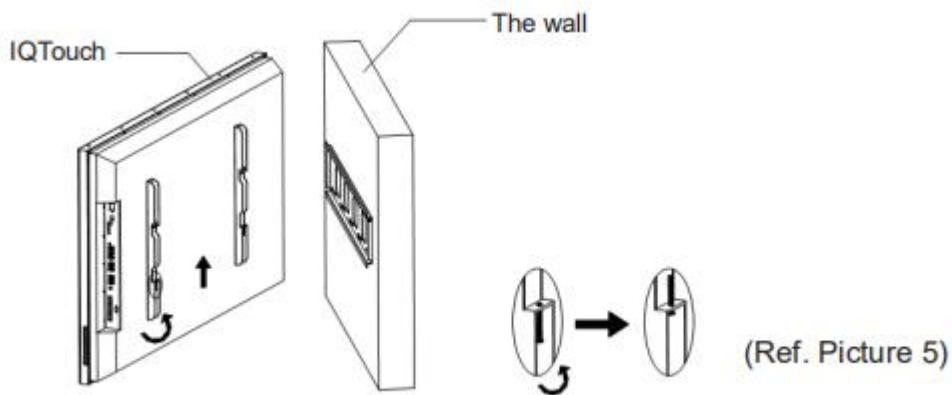

(Ref. Picture 5)

Note: The instruction just for installation diagram, it didn't appeared according to the actual size

## 1.2 OPS Installation

Note: The OPS does not support hot-plugging. Please insert the plug of the OPS after the interactive flat panel display is disconnected from the power.

Install the OPS by the following steps:

- 1) Insert the OPS into the special slot on the rear of the interactive panel.
- 2) Tighten the screws.
- 3) Confirm that the OPS is installed correctly.



Handle facing outward

## 2.Enable the Device

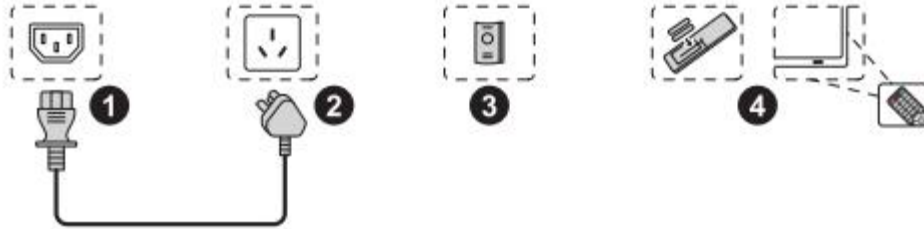

- 1) Connect the power cord to the port at the back of the device.
- 2) Plug the power cord to the electrical socket.
- 3) If the power LED light is not turn red please turn on the rocker switch at the back of the device.
- 4) Press power button or put the battery in to remote control and use remote control to power on the device.

### 3. Control Panel



Item	Icon	Function Description
1		IR receiver:Receive infrared signals such as remote control
2		Power button: On or standby mode
3		Touch USB cable to realize the touch function of external device
4		HDMI port used to connect an external display device
5		USB Type C: Image, power, touch, audio and video transmission
6		USB 3.0 port (Andriod & PC)
7		Light sensor: Automatically adjust screen brightness according to ambient light

### 4. Interface

#### Terminal Interface

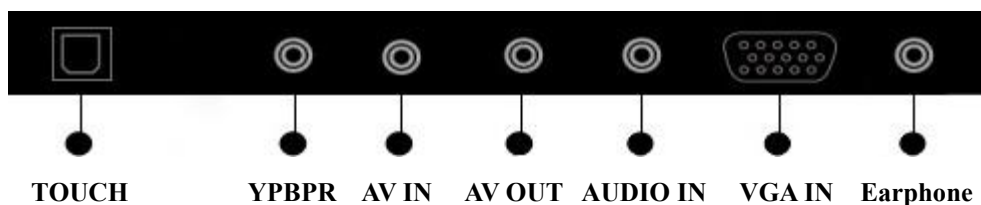

#### Side Interface

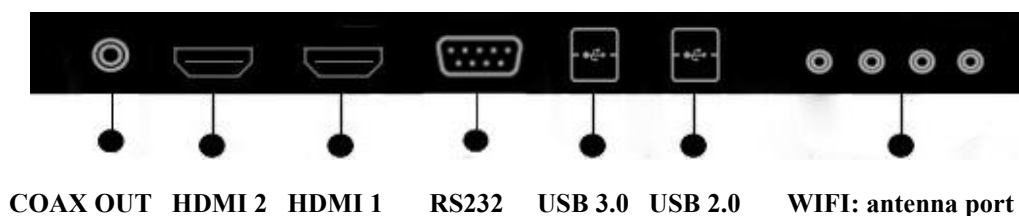

## 5.Remote Control



Button	Function Description
	Power on/off
	Mute
PC	OPS computer shortcut
VGA	VGA mode shortcut
HDMI	HDMI mode shortcut
MEDIA	Multi-media mode shortcut
F1-F12	Correspond to computer buttons F1-F12
Input	Select different input source
	Open/close backlight
	Up/down/left/right button
OK	Confirm
Menu	Open/close menu
Esc/Exit	Stop current operation or exit menu
VOL+/VOL-	Control sound volume
CH+/CH-	Select different input source
PgUp/PgDn	Next/previous page in ops mode
0~9	Input digit/"space" in OPS mode
Alt +Tab	Change window in OPS mode
Alt +F4	Close window in OPS mode

## 6.Remote Control Area

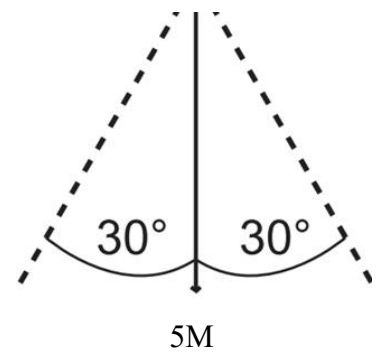
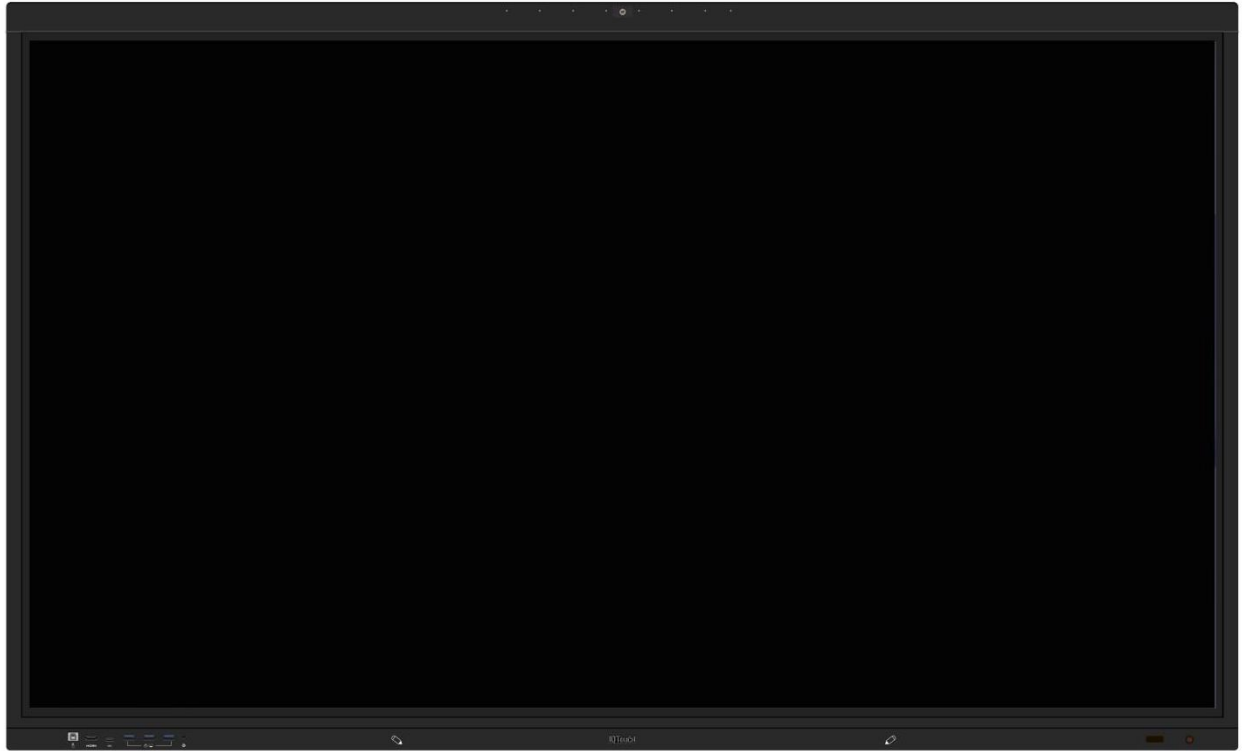



The effective receiving area is about 3 meters with  $30^\circ$  angle from vertical point to the left and right. And the effective receiving area is about 5 meters from the front of device. Note that the remote control signal receiver locates at the position of power indicator.

## 7. Connecting and Setting

For safety, please do not connect any power supply before the external devices setup.

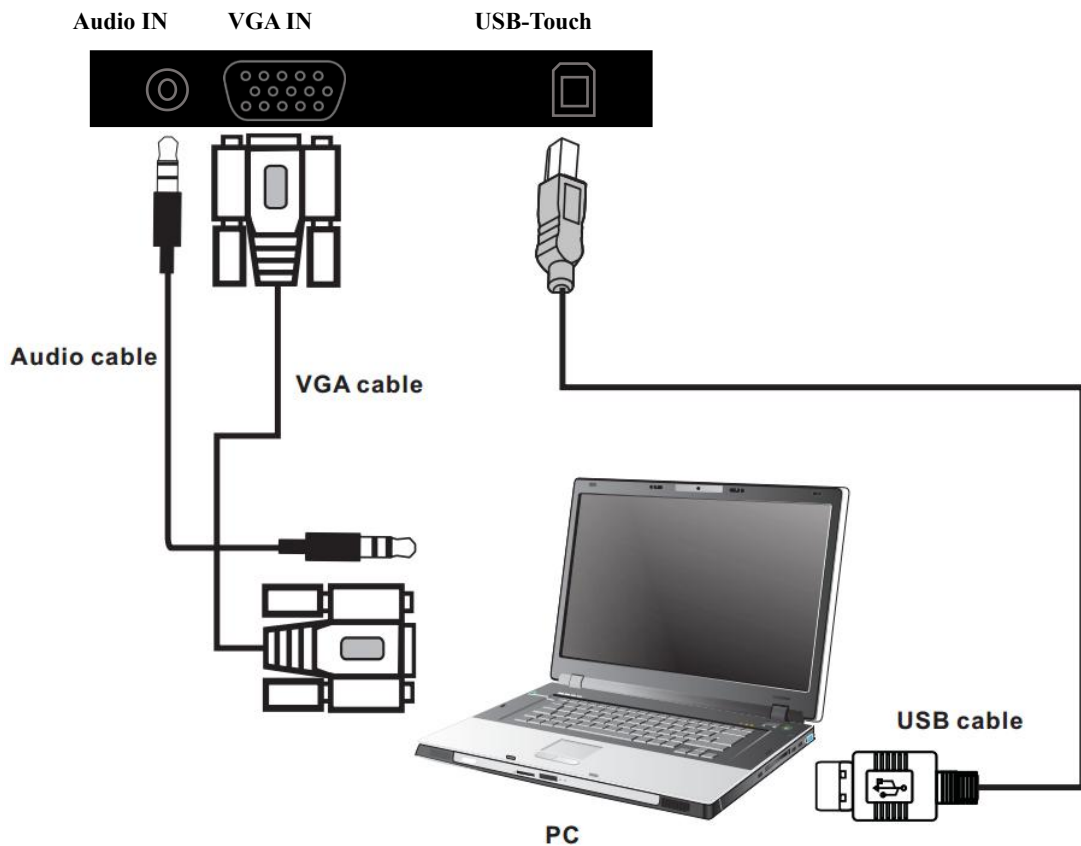
### 7.1 External Computer and Touch Connecting





- 1) Connect a VGA cable (15 pin) between the VGA and external PC. Connect an earphone cable between the PC and audio at the same time.
- 2) Connect a USB cable between the external PC and USB terminal.
- 3) Plug the POWER cord and switch it on from the rear panel.
- 4) Start up the external computer.
- 5) Press  to turn on the panel.
- 6) Select Signal source to VGA source according to the one you connected.

Note: The panel can connect with the external PC via HDMI.

## 7.2 AV Connecting

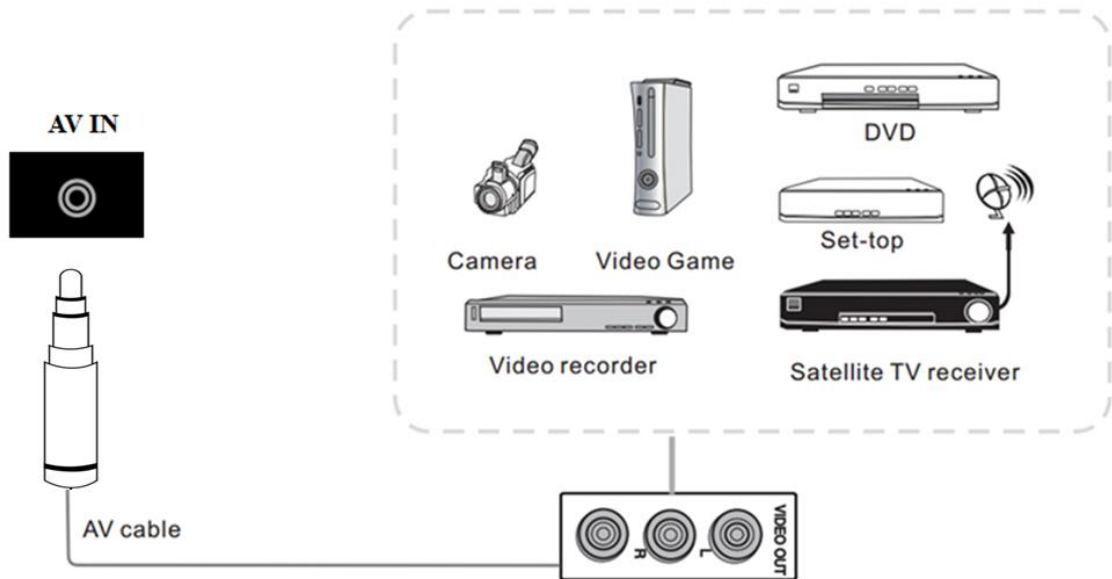
- AV IN



- 1) Connect an AV cable with the device with AV-OUT (Yellow is Video, Red is Audio-R, White is Audio-L).
- 2) Plug the POWER cord and switch it on from the rear panel.
- 3) Press  to turn on the panel.
- 4) Select Signal source to AV IN source.

- YPbPr

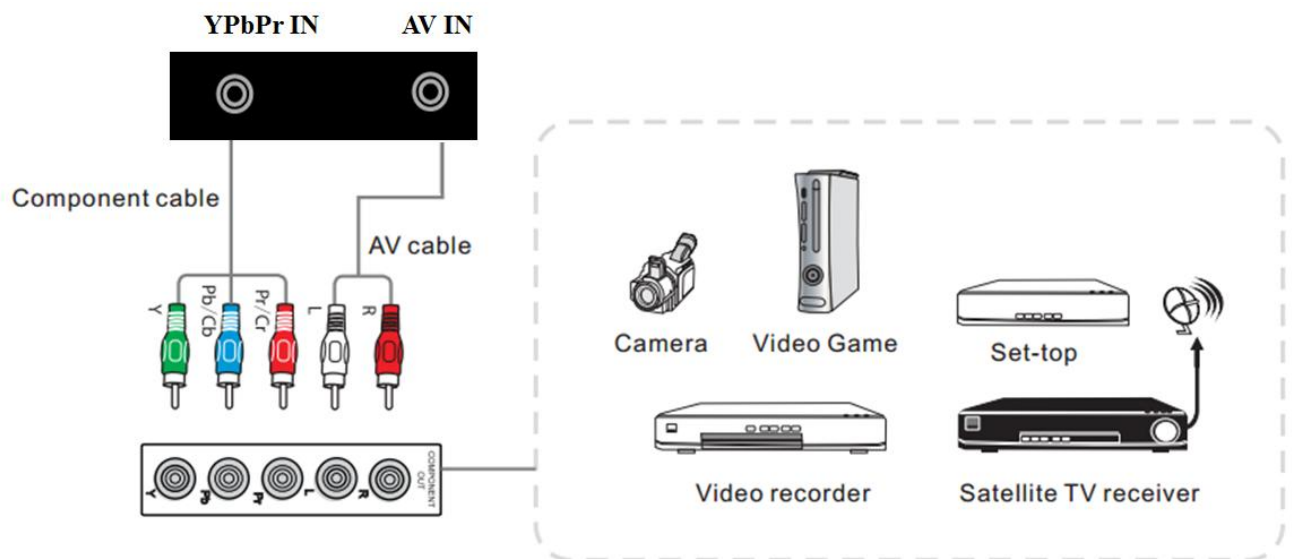

- 1) Connect a YPbPr cable with the device with YPbPr.
- 2) Plug the POWER cord and switch it on from the rear panel.
- 3) Press  to turn on the panel.

4) Select Signal source to YPbPr source.

● **Front HDMI/ HDMI 1/ HDMI 2**

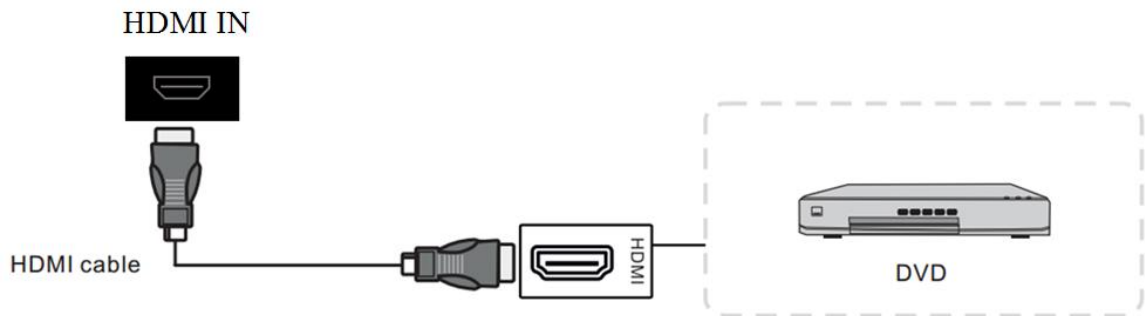

- 1) Connect a HDMI cable with the device with HDMI.
- 2) Plug the POWER cord and switch it on from the rear panel.
- 3) Press  to turn on the panel.
- 4) Select Signal source to HDMI source according to the one you connected.

### 7.3 Video-OUT

● **HDMI-out**

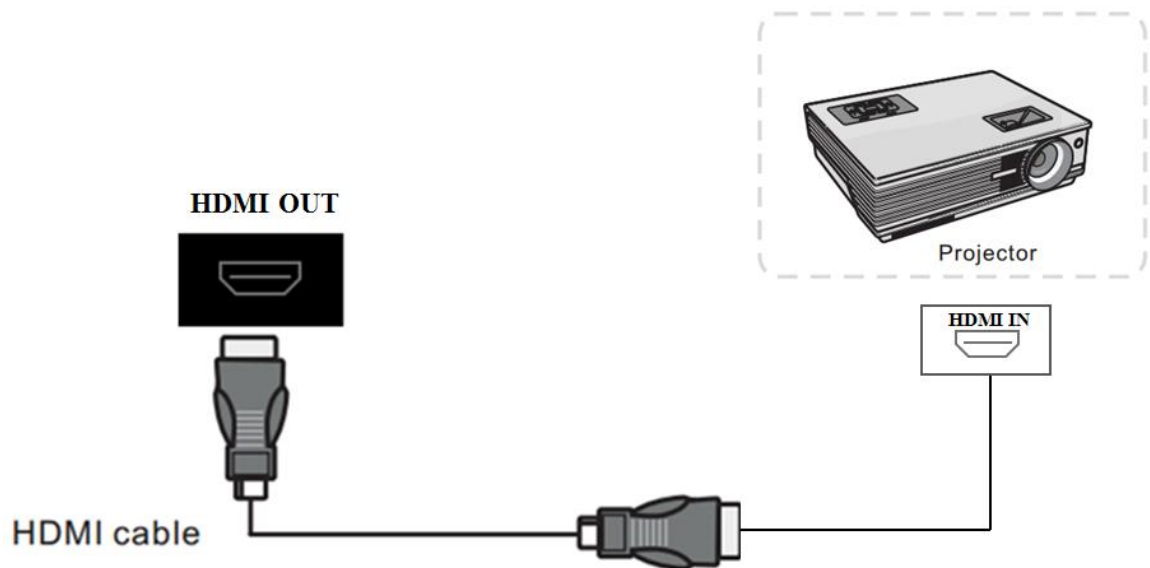

- 1) Connect a HDMI cable with the device with HDMI.
- 2) Plug the POWER cord and switch it on from the rear panel.
- 3) Press  to turn on the panel.

## 7.4 RS232

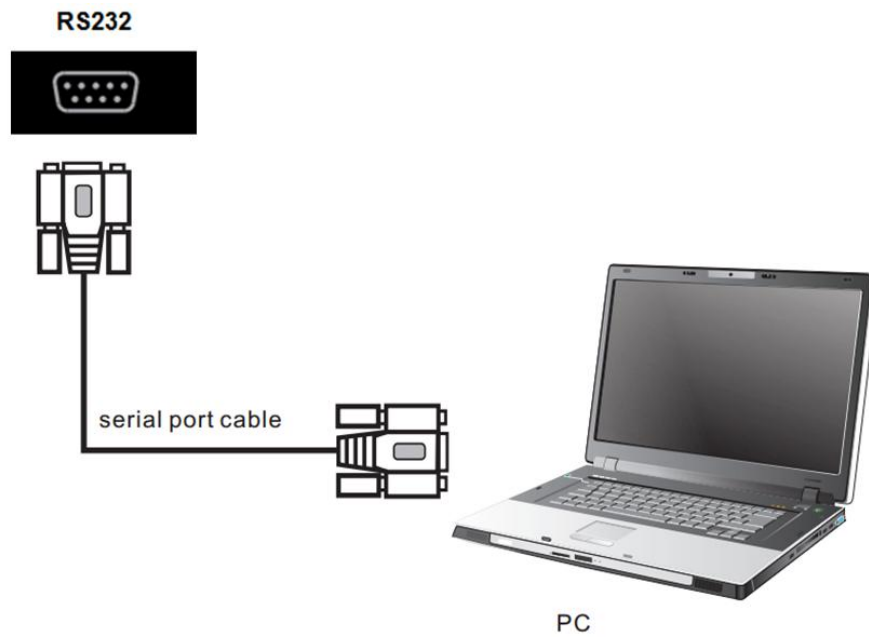

- 1) Connect a serial port cable with the device.
- 2) Plug the POWER cord and switch it on from the rear panel.
- 3) After connecting the central control system and unit, you can use some of the function such as power on/off or adjust the volume etc.

## RS232 code list

<b>RS232 Code for Android Firmware</b>	
<b>16-byte command, baud rate 115200</b>	
<b>Start code 99, client code 23, function ID code, device ID code (generally 01 without special instructions), check code + function ID code = FF, end code AA</b>	
<b>Function</b>	<b>Required Commands(Hex)</b>
Power ON	99 A2 01 00 27 AA
Power OFF	99 A2 01 01 27 AA
HOME	99 23 00 01 FF AA
Mute	99 23 02 01 FD AA
Image mode	99 23 04 01 FB AA
Color difference	99 23 0A 01 F5 AA
VGA	99 23 0B 01 F4 AA
HDMI 1	99 23 0E 01 F1 AA
HDMI 2	99 23 0F 01 F0 AA
Front HD	99 23 10 01 EF AA
Built-in computer	99 23 11 01 EE AA
Menu	99 23 12 01 ED AA
Signal source	99 23 13 01 EC AA
Exit	99 23 14 01 EB AA
Listen alone	99 23 16 01 E9 AA
Sound (+)	99 23 17 01 E8 AA
Sound (-)	99 23 18 01 E7 AA
Whiteboard	99 23 20 01 DF AA
OK	99 23 26 01 D9 AA

## 8.Android Home Page



Enter the Android interface by default after power on. It is renewed slideable three-homepage.

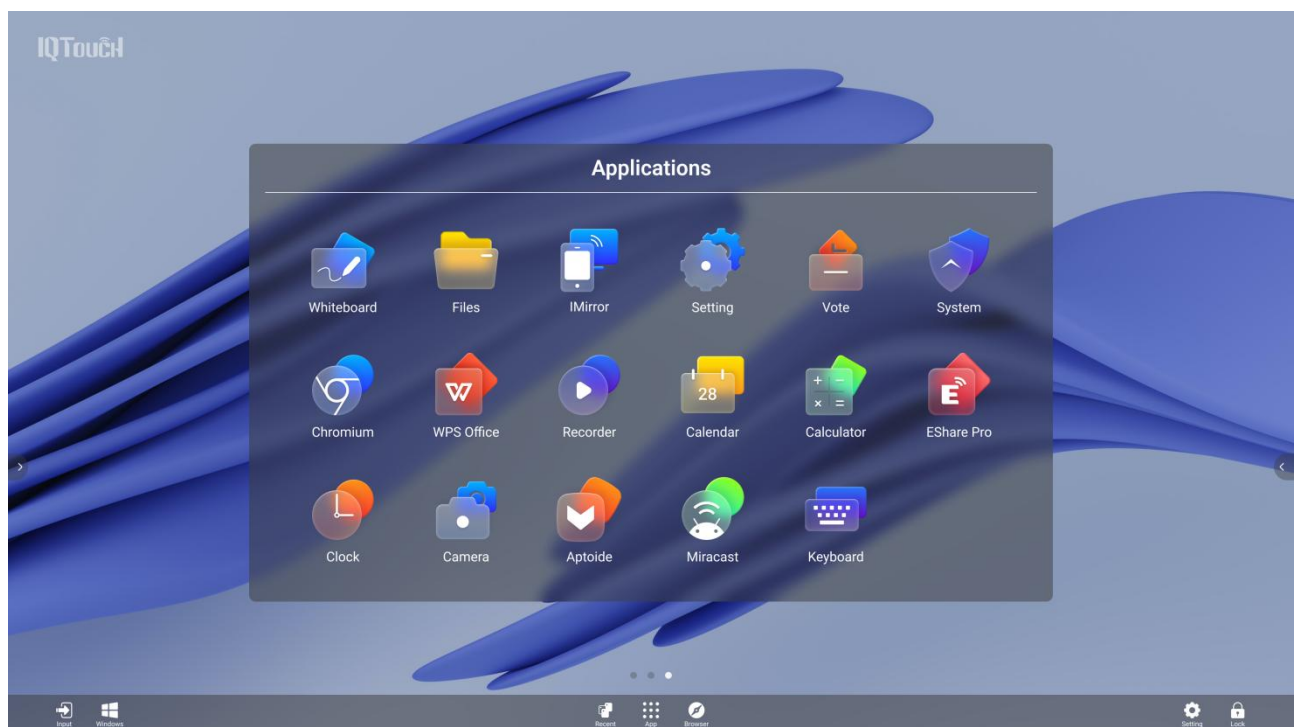

Slide to the left, all the applications are presented. Users can view or open the APK application installed by themselves in this interface, as shown in the figure.

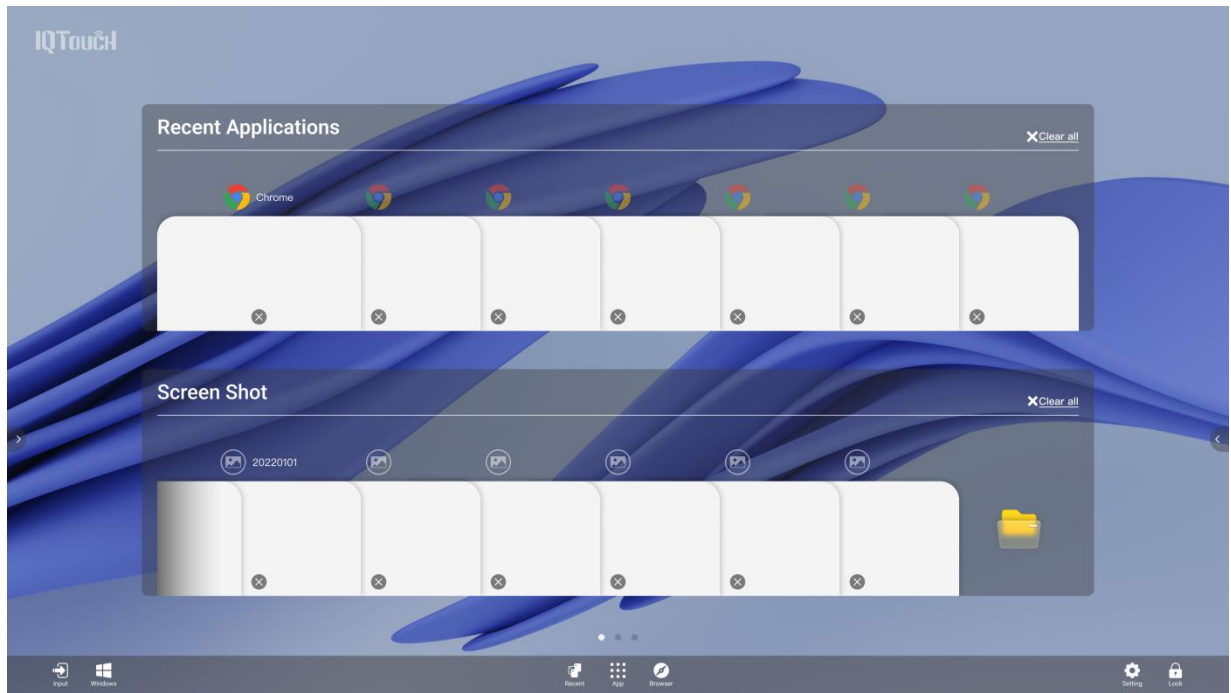

Slide to the right, the recent applications and screen shots are presented right there for quick access.



## 8.1 Floating menu



1. The icon floating on the desktop can be moved freely and displayed in any interface.
2. Add: Click the icon it will show the pop-up menu.



## 8.2 Sidebar

The sidebars are divided into left sidebar and right sidebar. Click on the icon  ,  floating on the left and right side of the screen to show the sidebar. The functions are Home page, Back, Annotation, Capture, Freeze, Control panel, and Input.



## Home

Click  icon to enter the main interface of Android system.

## Back

Click  icon to return or exit the current program.

## Annotation

Click  icon to open the annotation.

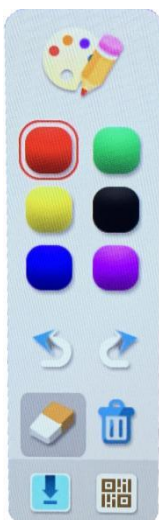



Click  to choose the pen color.

Click  to undo or forward the operation.

Click  to open eraser mode.

Click  to clean all the annotation.

Click  to share scan QR code. You can scan code to save the files to your own mobile device.

Click  to insert whiteboard.

Click  to exit the annotation mode.

## Control panel

Click  icon to display the notification panel as shown below. The Notification Center panel contains calendar, screen lock, energy save, screen shot, eye protection, spotlight, camera, curtain, timer, and customize.



### 1) Calendar

Click  icon in the notification panel to show the calendar interface that user can check time and mark the events.

### 2) Screen lock

Click  icon. If the system is in lock screen status, the functions of touch, click, and remote control are all locked which cannot be used.

The unlock method is as follows:

- Password unlock: touch screen to input 2580 password, and then click OK to unlock.

(The initial password is 2580, the user can enter the settings to change the password.)

- Remote unlock: Press F9 of the remote control to quickly unlock.

▪ Combination key unlock: Press the signal source key twice, then press the sound+ and the sound -.

Note: It is only possible to press sound+ and sound - under the signal source interface.

### 3) Record Screen

Click  icon to record the screen of current content for meeting recap playback.

### 4) Screen shot

Click  icon to achieve full-screen screenshot or free screenshot.

### 5) Vote

Click  icon to open the multi-person voting function .

### 6) Spotlight

Click  icon to highlight the content with spotlight function.

### 7) Camera

Click  icon to open the camera function.

### 8) Curtain

Click  icon to open the curtain function and use the existing background template to block the content on the screen.

### 9) Timer

Click  icon for countdown.

### 10) Energy Saving

Click  icon to enter the screen backlight status, touch the screen or use the button, energy save button of remote control to turn off energy saving.

### 11) Eye protection

Click  icon to turn on or off the eye protection function.

### 12) Sound and brightness adjustment

Sound adjustment: move sound progress  7  to adjust the volume.

Brightness adjustment: move backlight progress  11  to adjust the brightness.

### 13) Quick Apps

Click the icon to enter the corresponding application

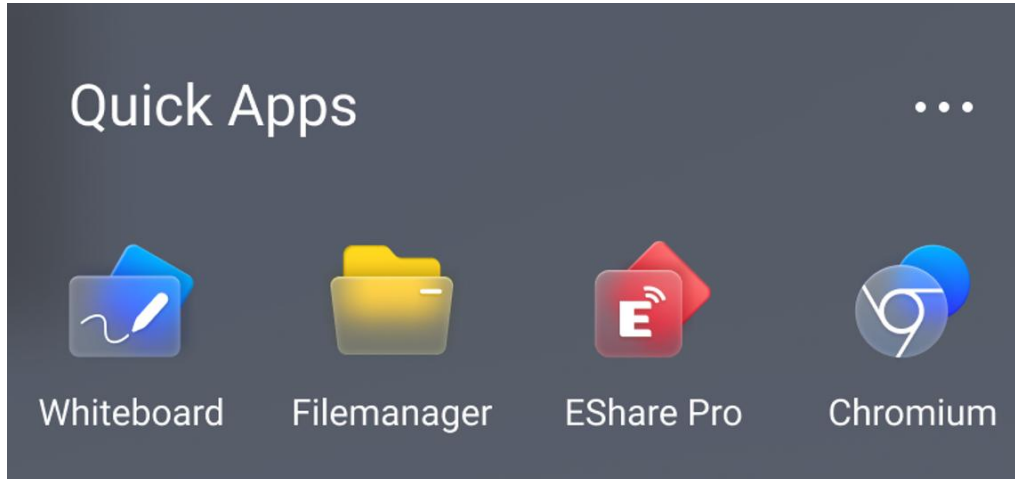

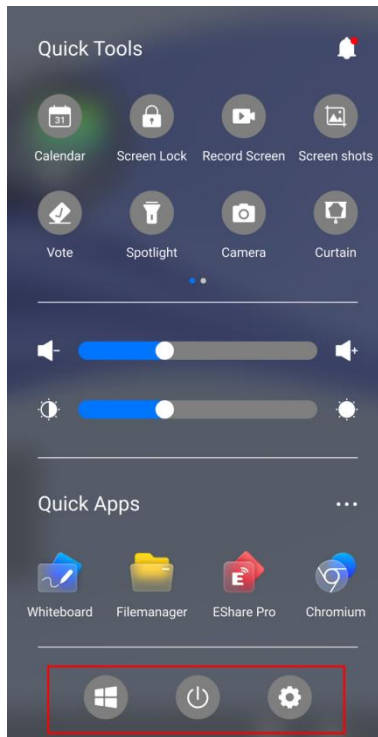

Click  to enter more applications.

### 14) Bottom bar



OPS: Click  icon, user can switch directly to the built-in computer channel.

Shut down: Click  icon, the display powers off.

Setting : Click  icon to enter the system settings interface.

## Input

Click  icon to show the source channel list, and the user can switch channel.



## 9.Android Settings

Click setting icon  on home page to enter Android setting interface.

### 9.1 Individualization

#### Basic

You can adjust the system's sound and brightness, change the system theme wallpaper, modify the device name and view the system application on basic settings interface.

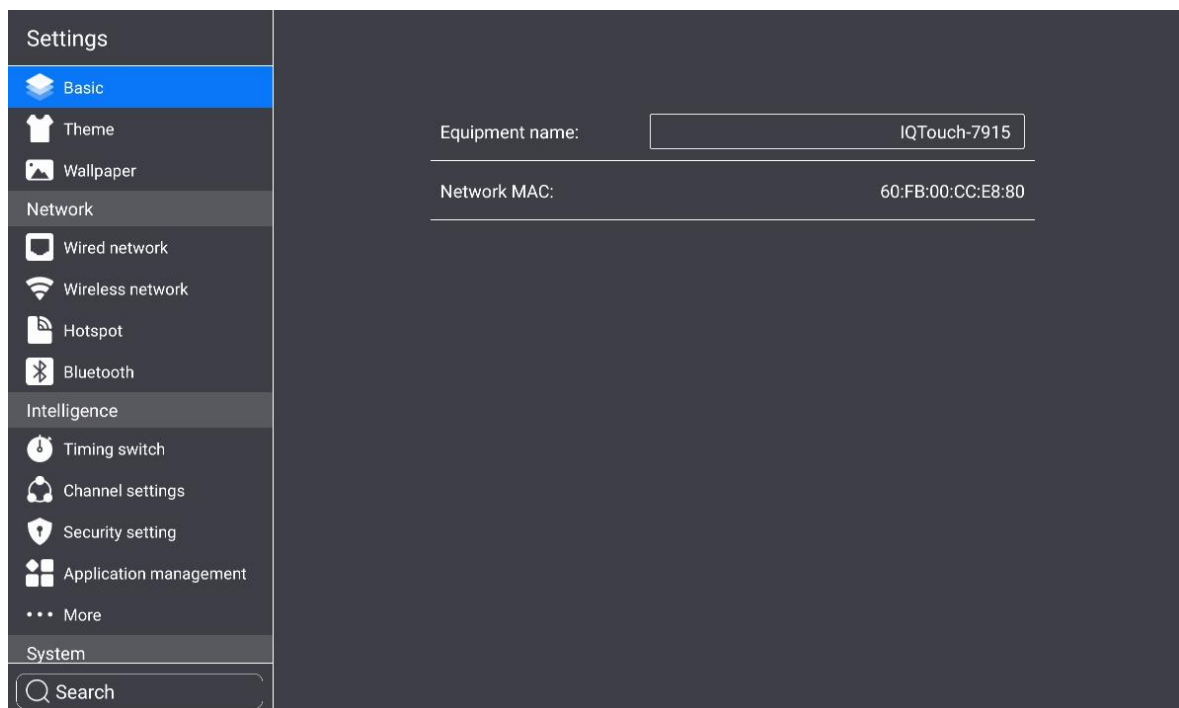

Equipment Name : Users can modify the name of the interactive flat panel display.

Network MAC: Display the MAC address of the currently connected network.

#### Theme

Click on the corresponding theme image to switch meeting theme, education theme, technology theme.



## Wallpaper

Wallpaper has live and dynamic wallpaper. It also can be added by custom. Custom added wallpaper can be stored in live wallpaper and deleted by long press.

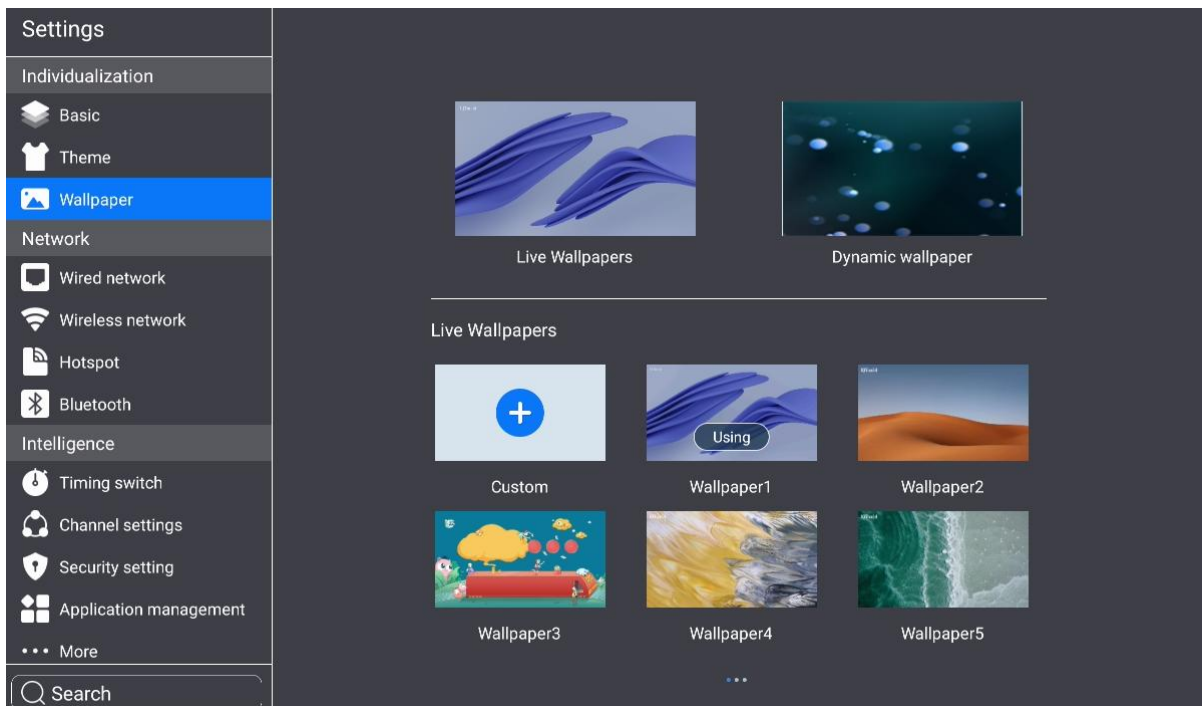

## 9.2 Network

### Wired network

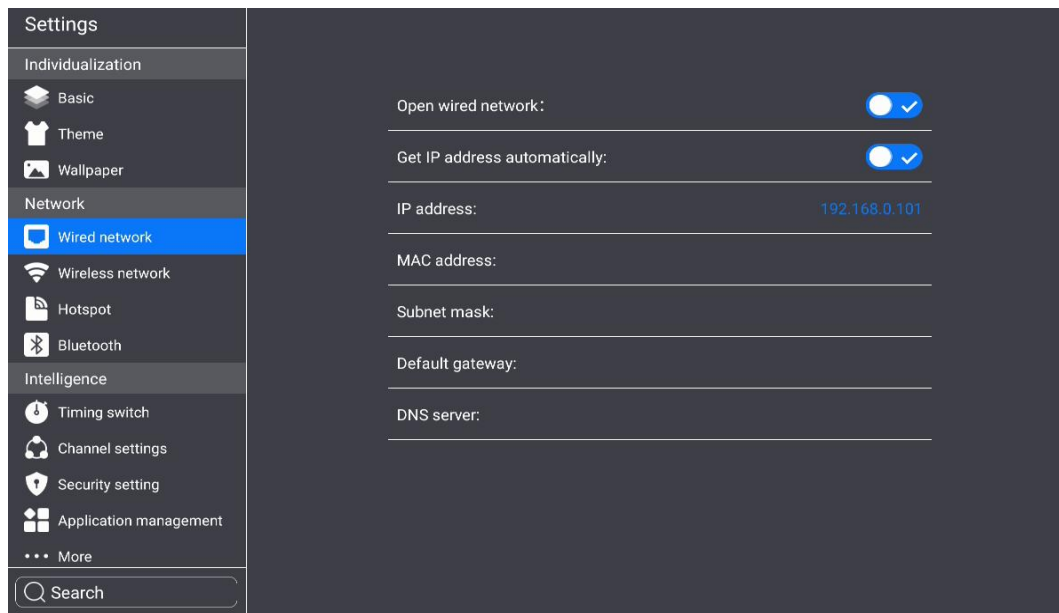

Under the wired network interface, users can view the MAC address, IP address and other information. The automatic access to the IP address is opened by default, and the parameters such as the IP address and the subnet mask can be manually modified after the automatic acquisition is closed.

### Wireless network

Turn on the wireless network, which automatically connects the display to the available wireless network.

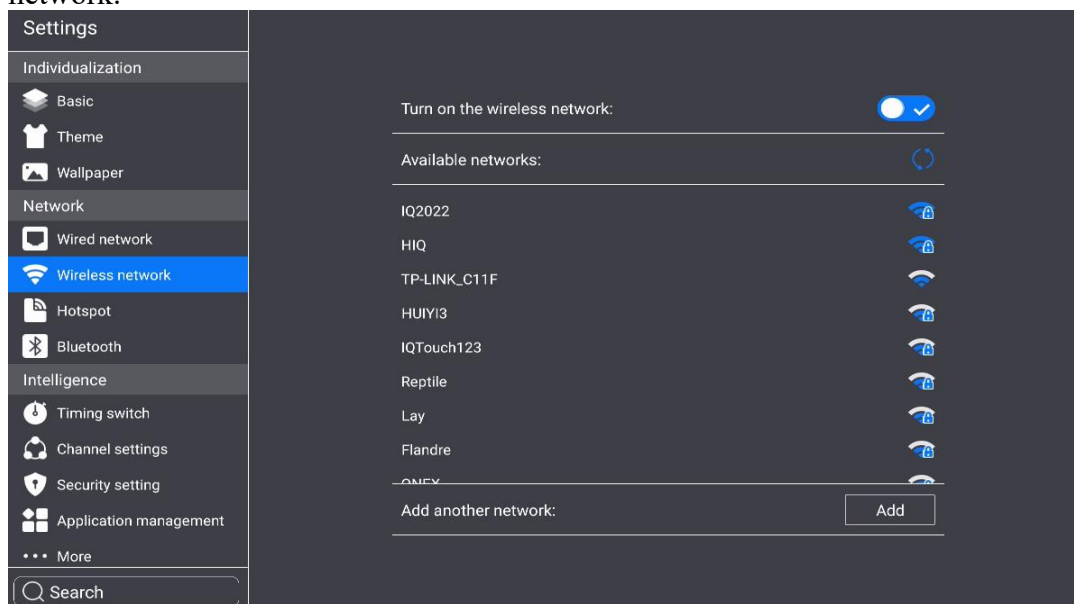

## Hot spot

Under the 2.4 and 5G hot spot settings interface, users can change the hot spot name, security, password and other parameters.

Notice: 2.4G and 5G hot spot, 2.4G hot spot and wireless network can neither be opened at the same time.

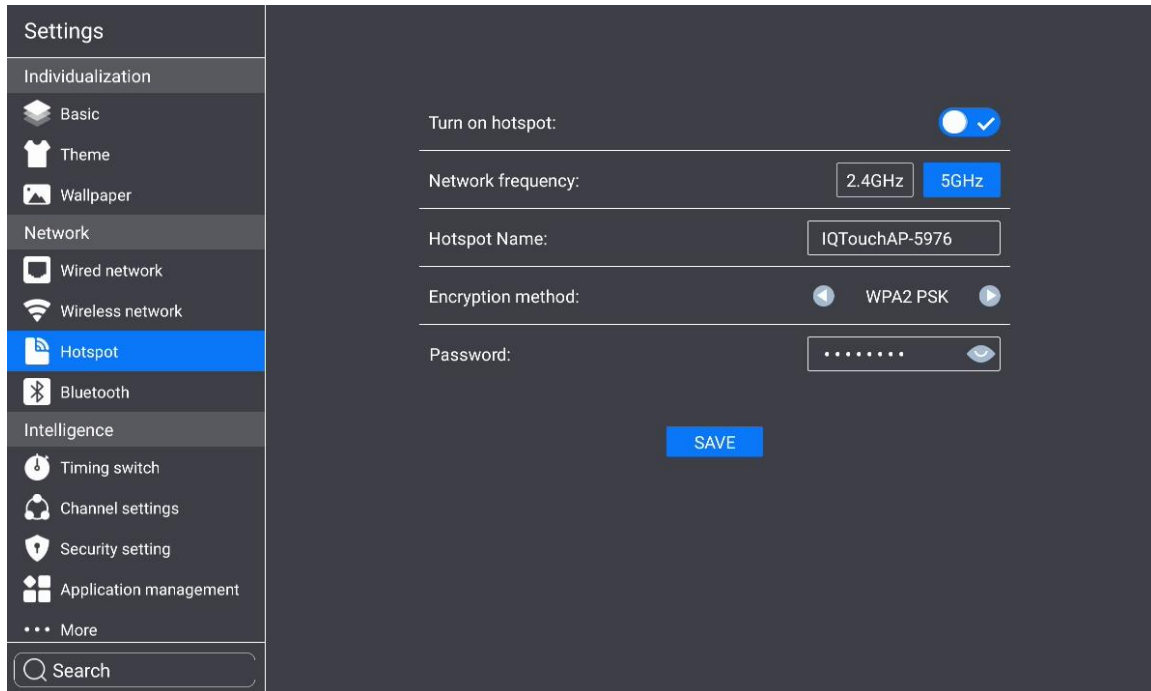

## Bluetooth

Turn on Bluetooth function to achieve Bluetooth transmission after Bluetooth pairing.

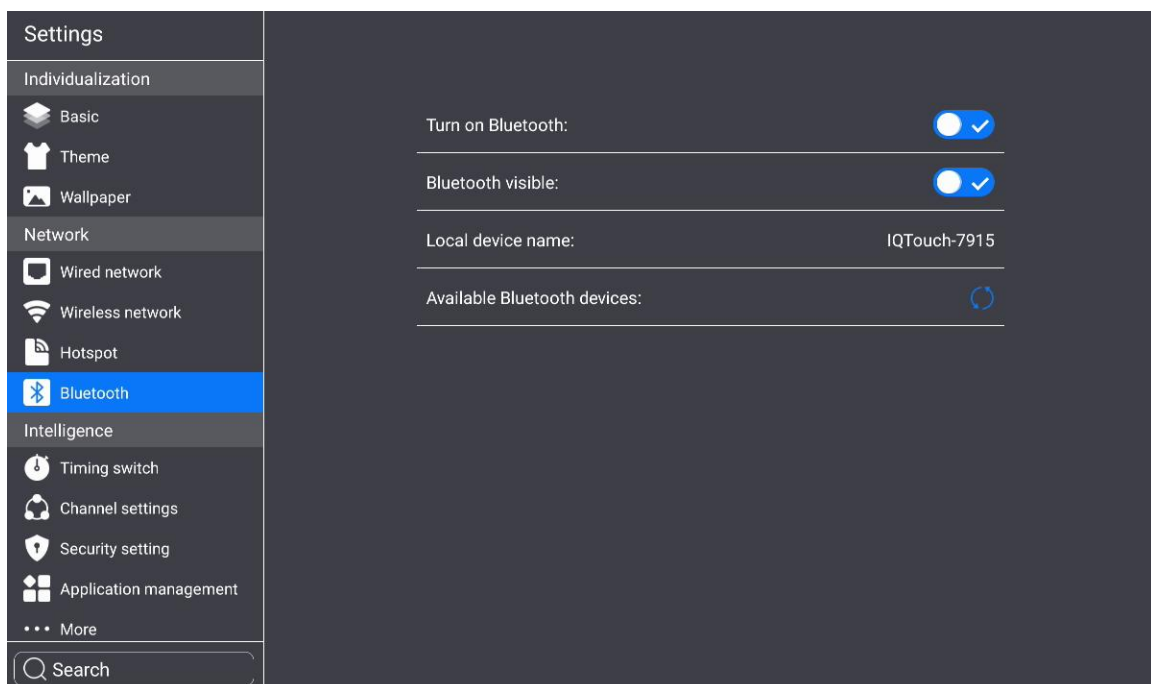

## 9.3 Intelligence

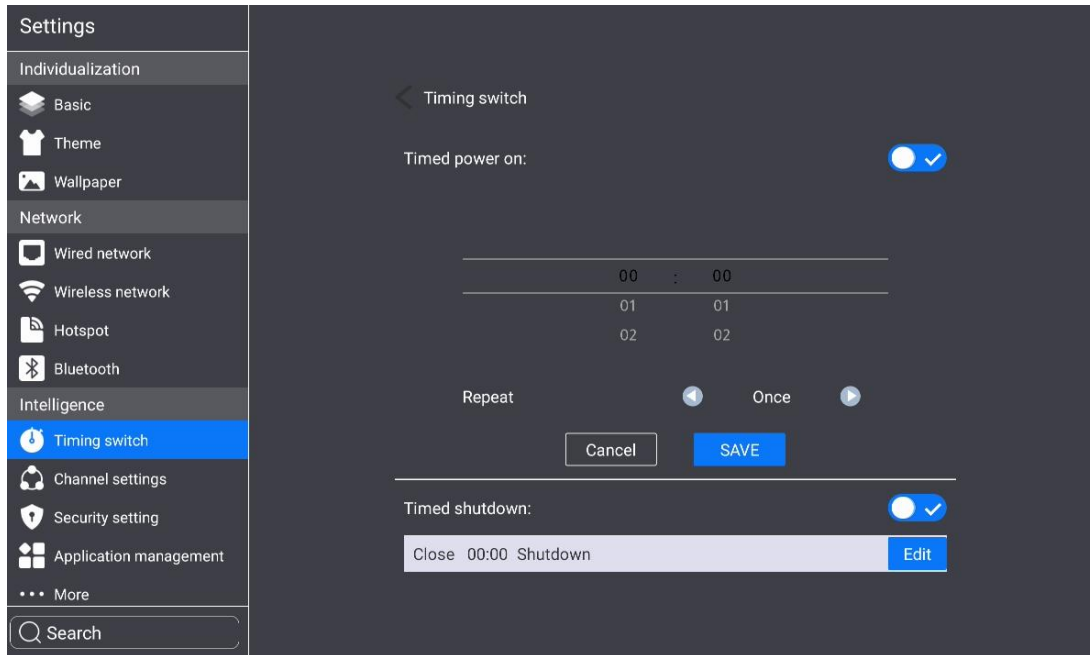

### Timing switch

After setting the power-on time and power-off time, the system will automatically power on or off when the scheduled time is up.

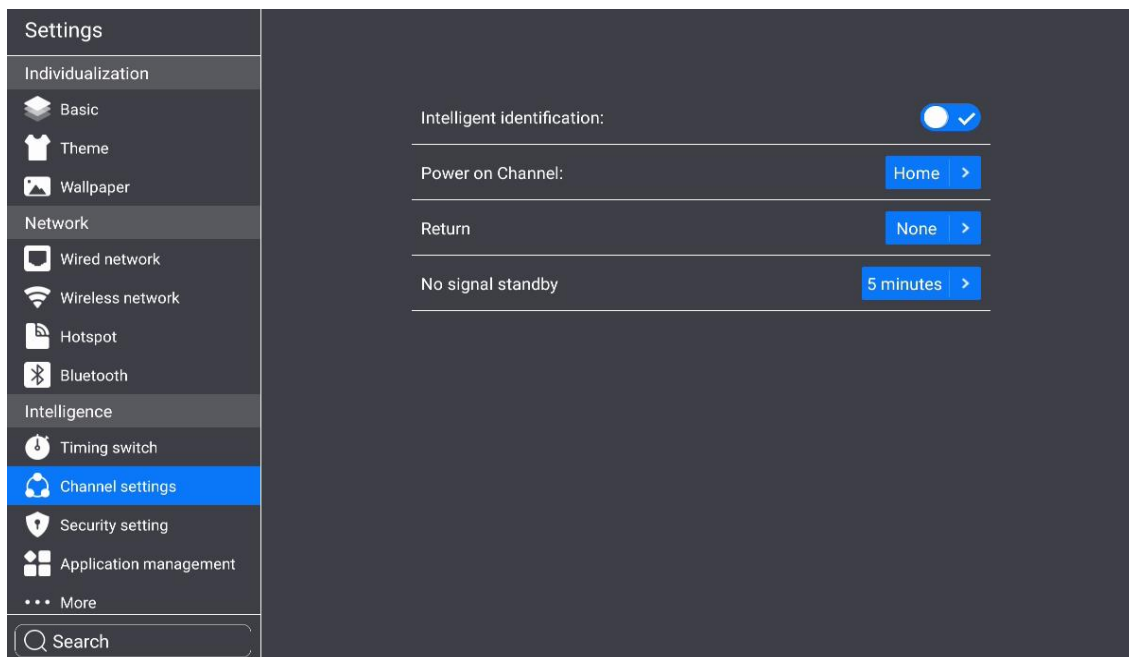

### Channel settings



Click  to set Power on Channel or click  to custom channel name.

## Security settings

USB lock, screen lock, and application lock can be turned on or off. You can also set the corresponding unlock password, the initial password is 2580.

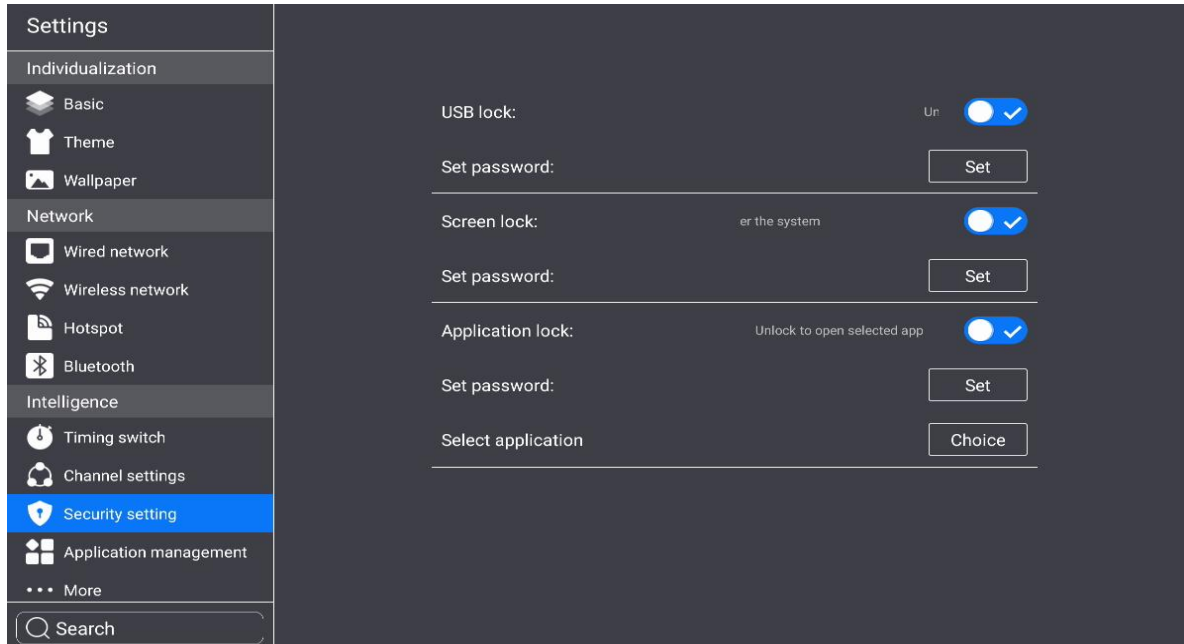

Click Set Password to change the corresponding password.

## Application management

All applications in the list can be managed, click  to setup the corresponding applications.

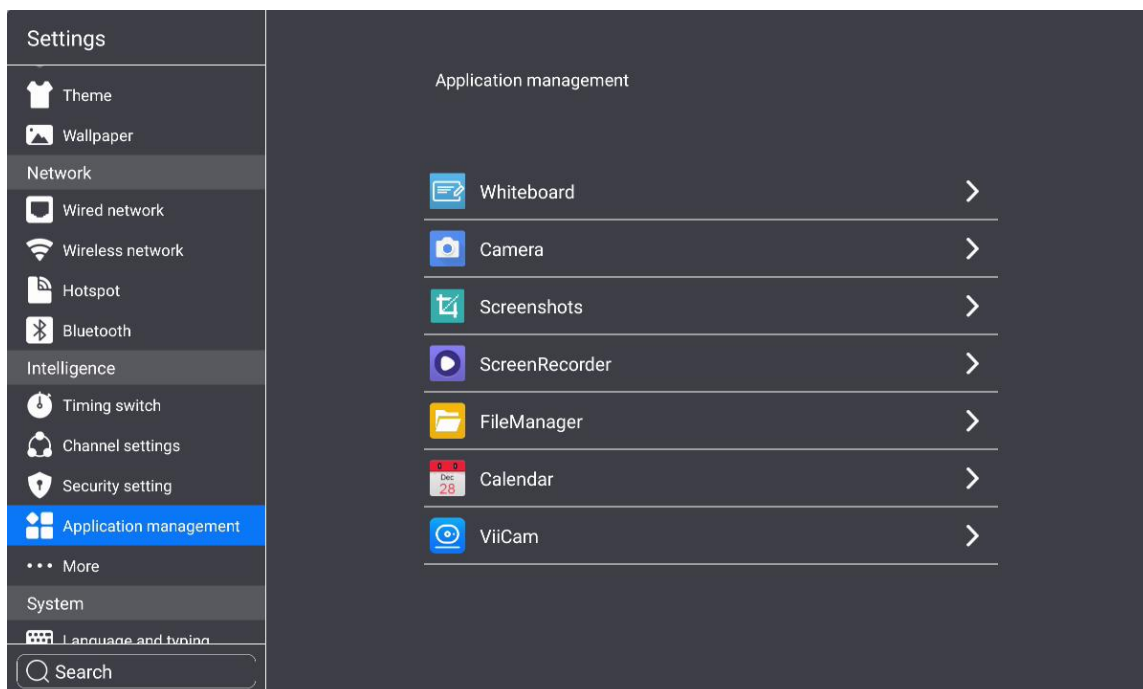

## More functions

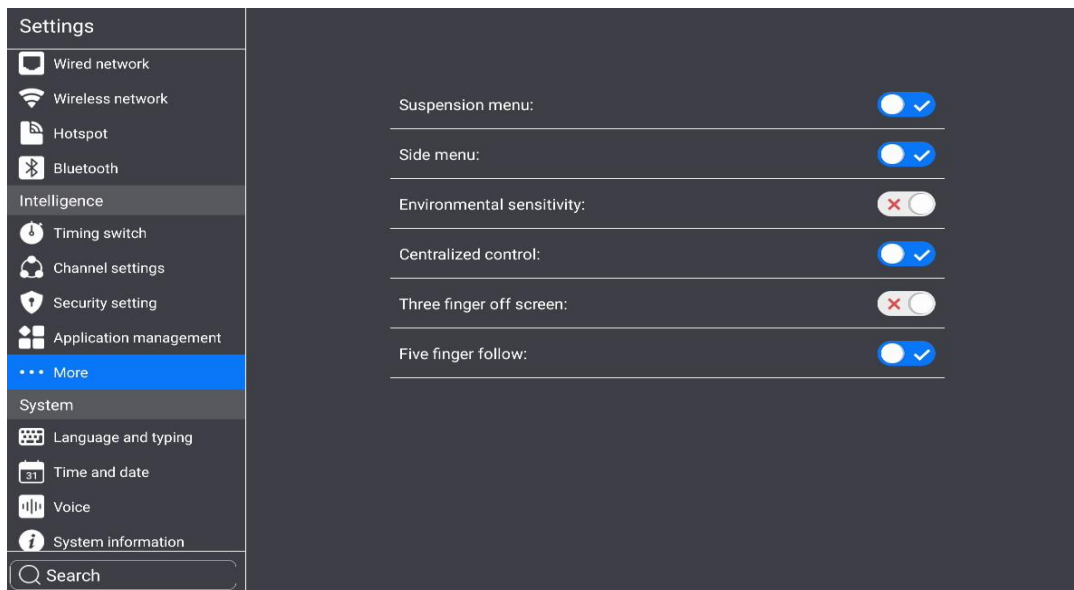

You can set the suspension menu, sidebar, environmental sensitivity, centralized control, three-finger off screen and five-finger follow.

## 9.4 System

The system setting options are mainly for system input method, language display setting, system update and upgrade, etc., as well as system version information and built-in storage usage.

### Language and typing

Click  to set the language ( English, Arabic, Spanish, French, Italian, Japanese, Portuguese, Russian, Korean, German, Simplified Chinese, Traditional Chinese), and you can also set the input method.

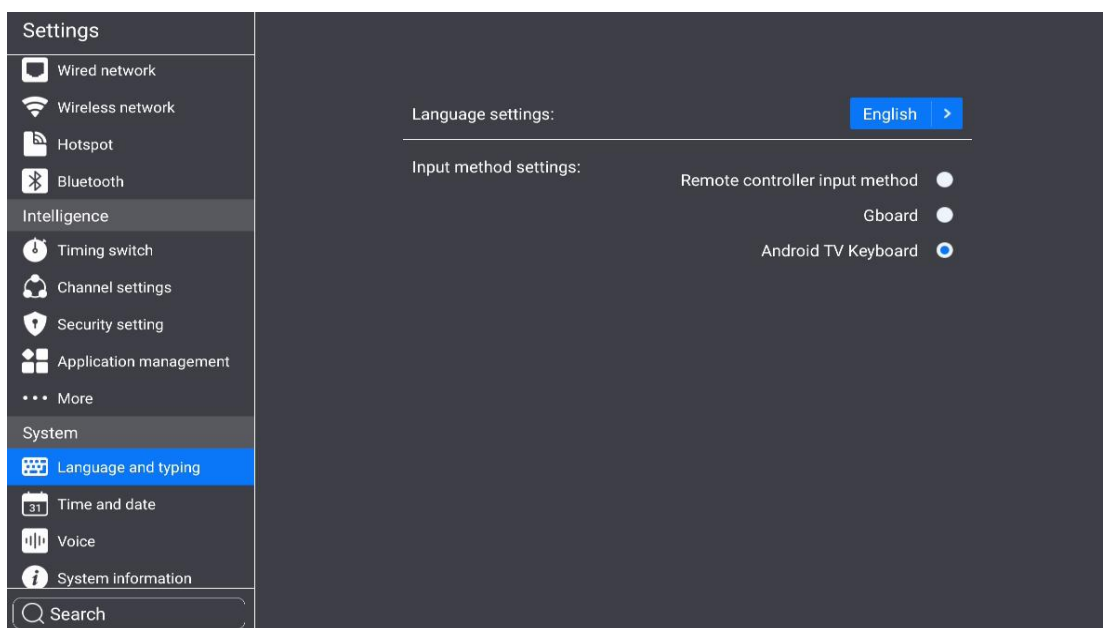

## Time and date

Turn on the Auto set time. If the network connection is successful, the current network time will be automatically synchronized. When the Auto set time is off, you can manually set the date and time.

Click  to change the time.

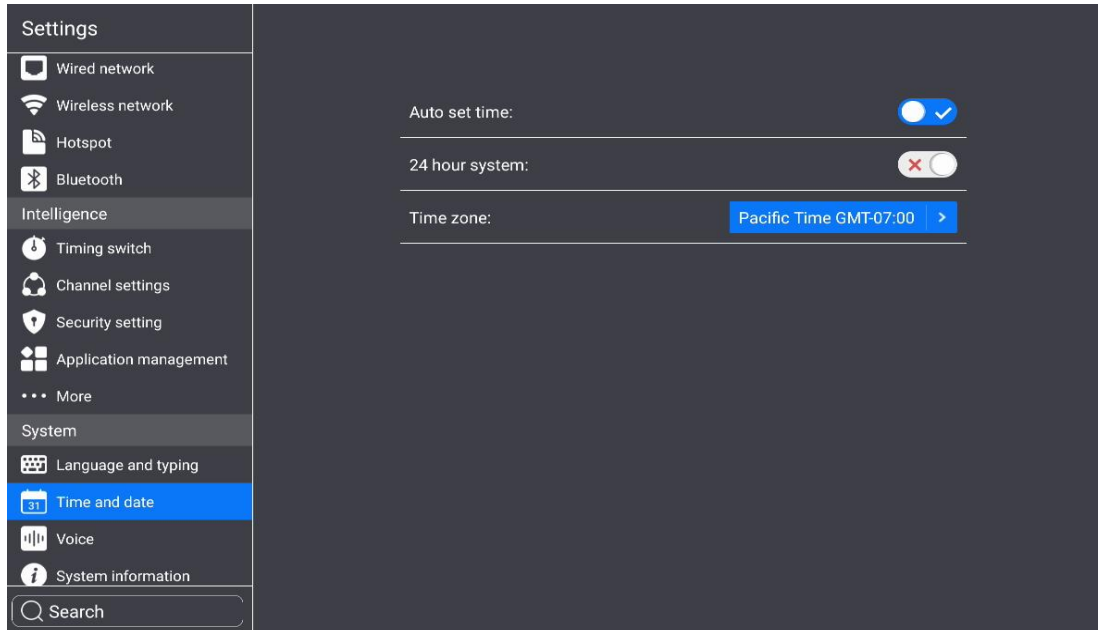

## Voice

Adjust volume and set sound mode, output device.



Sound mode: standard, news, music, theater, sports, user voice output device: speaker, coaxial, Bluetooth, USB mode.

## System information

You can view the system version information and built-in storage usage and other information.

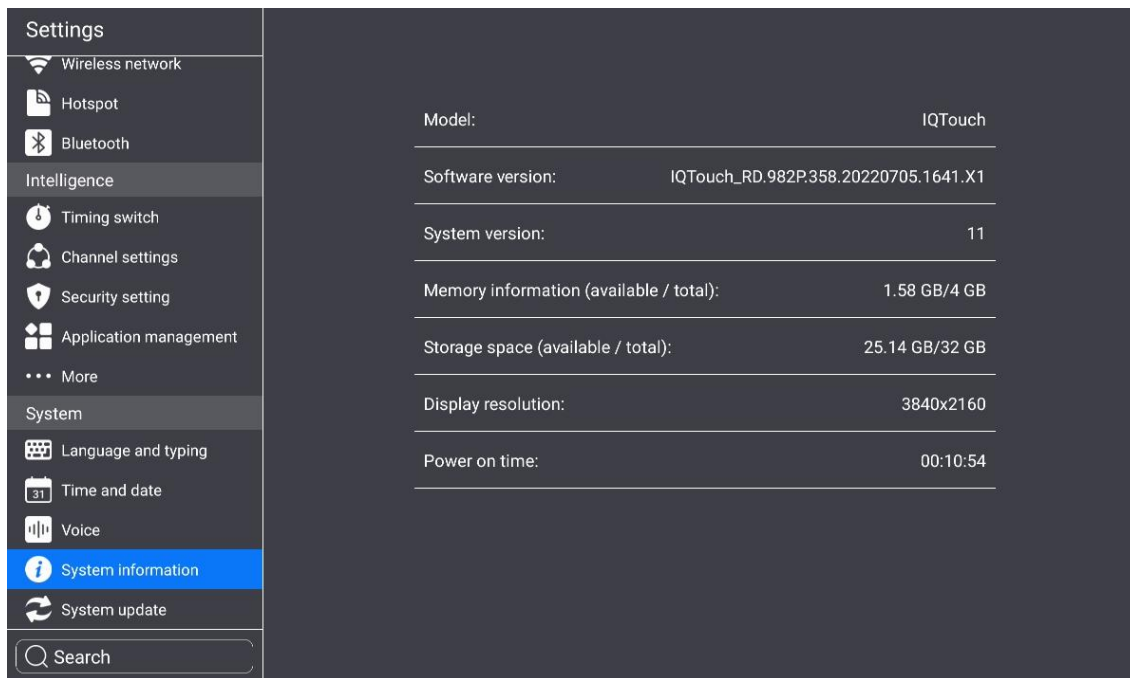

## System update

- 1) Restore factory settings: click Reset to restore the factory settings.
- 2) Local update: Copy the firmware to the root directory of the U disk, insert the U disk into the multimedia USB interface of the machine, and select local upgrade and update.

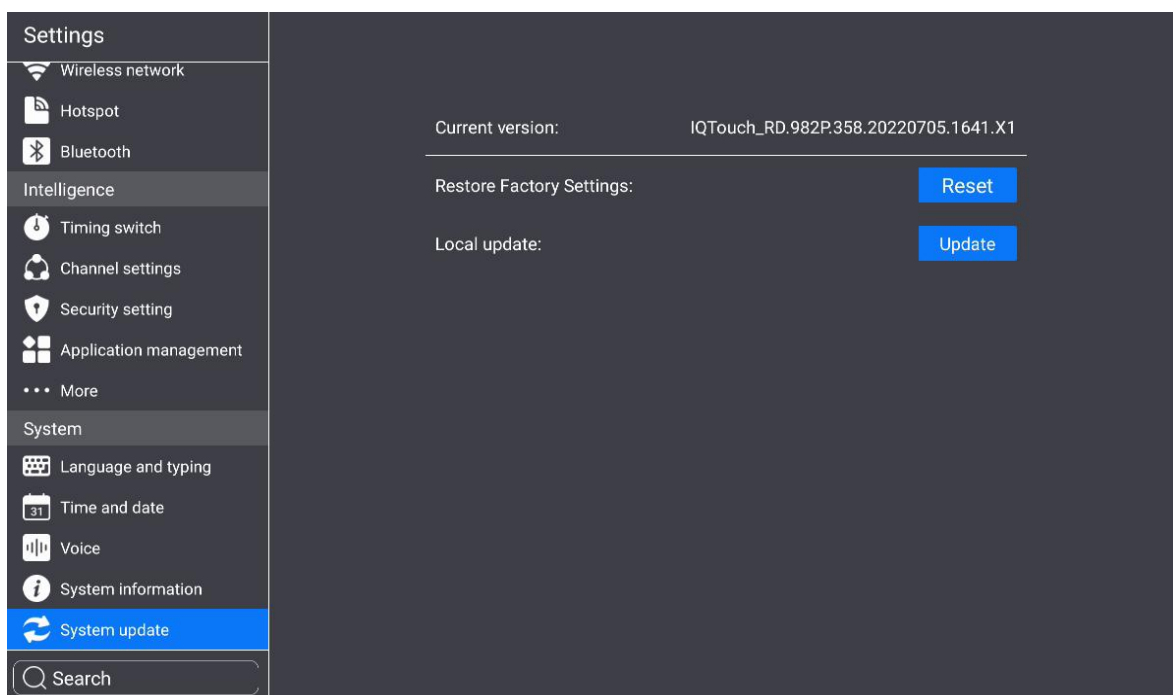

## 10. Whiteboard App

### 10.1 Interface Display

Click  the whiteboard icon in the main interface to start the whiteboard software.

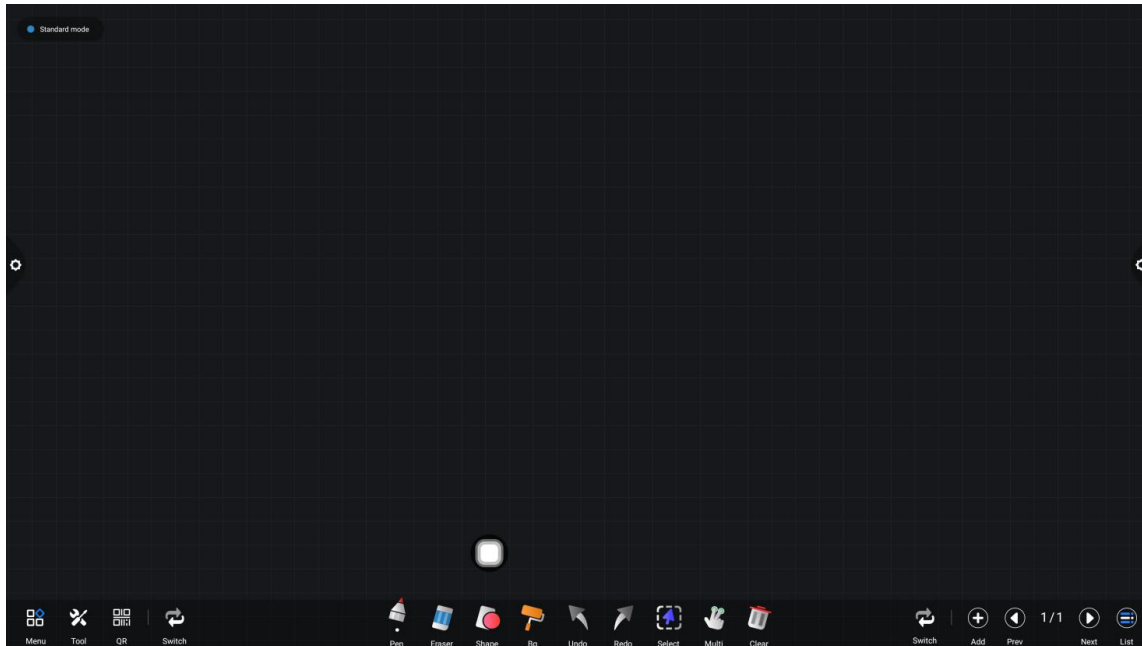

1. The whiteboard is selected by default and can be written directly.
2. Support single point mode and multi-point mode, multi-point support up to 20 points.
3. Single point mode, two fingers or more to perform zoom roaming function. It supports single stroke mode and double stroke mode, and the double pen mode is for stroke writing.
4. Support small tools, insert pictures and shapes, draw lines and arcs. You can also use some of the system's small tools, such as camera, calendar, calculator, etc.

## 10.2 Menu

Click  (menu icon) in the lower left corner of the interface, pop up display and display the lower content menu.

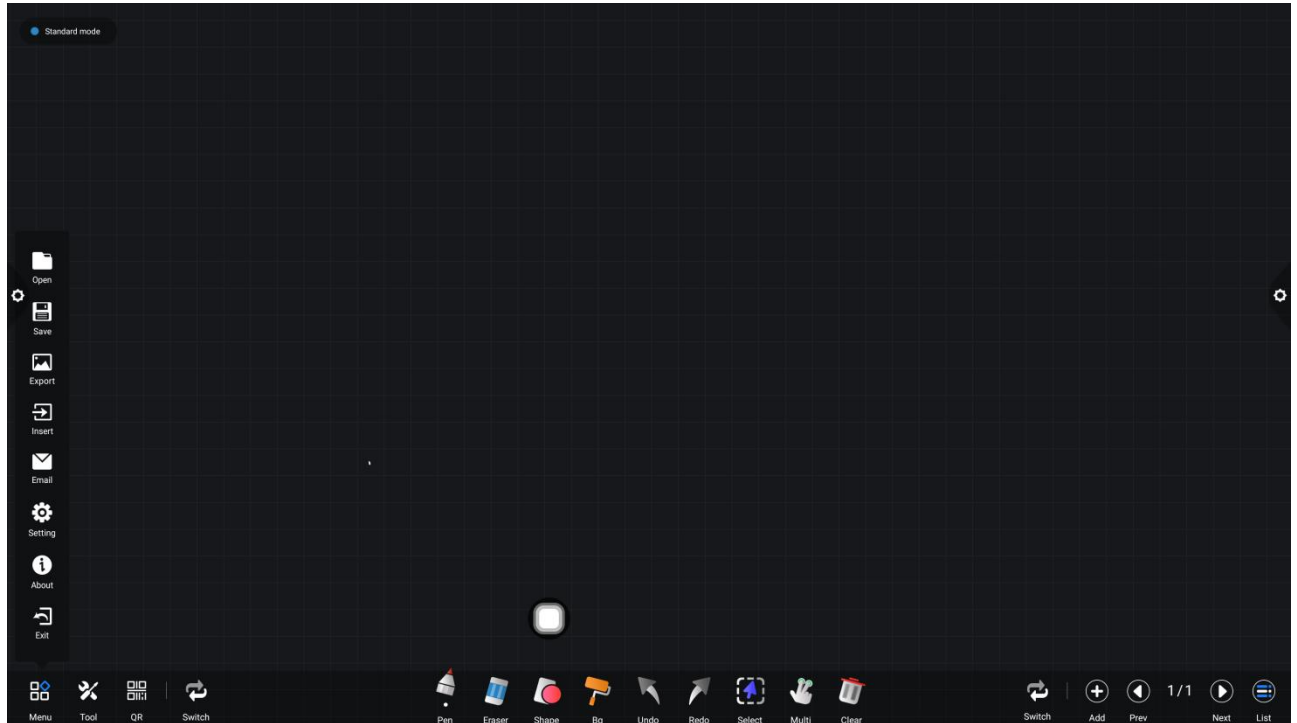

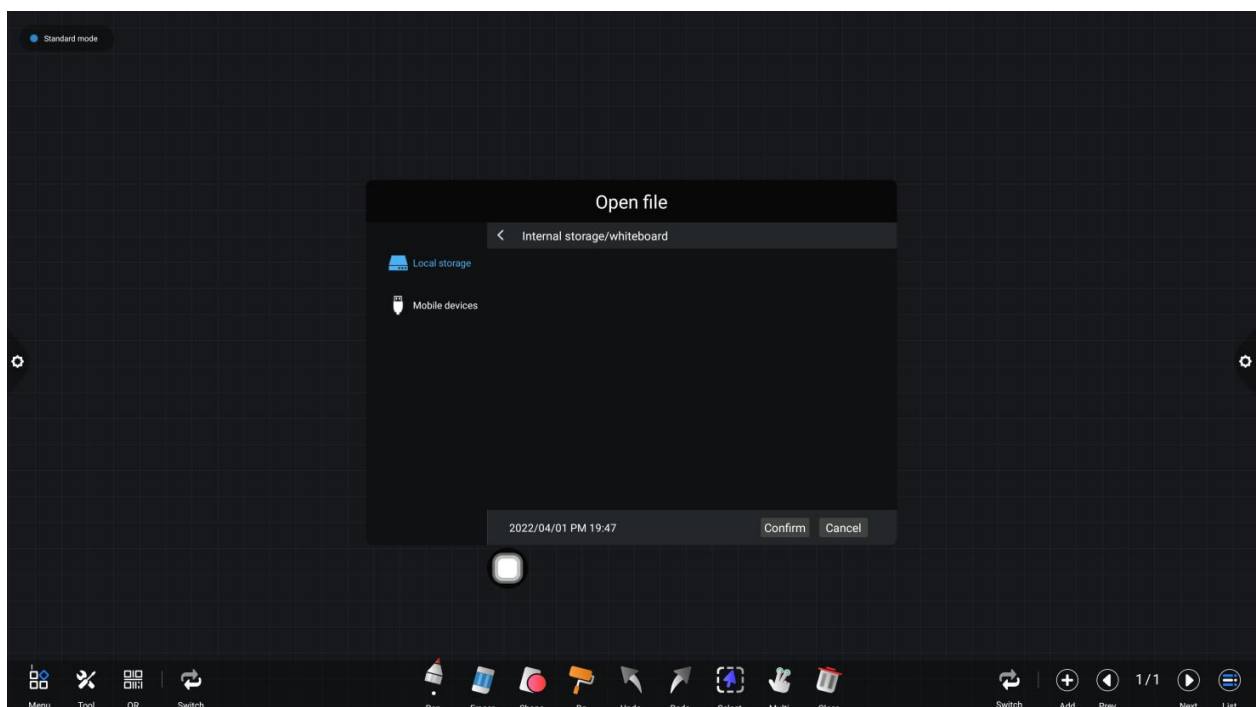

Content menu icon function operation instructions:

- (1) Open the file: Click  the icon to open and save the file under the whiteboard file directory (the default path directory is built-in storage / writeboard), click the file to open directly, and you can edit and save again.

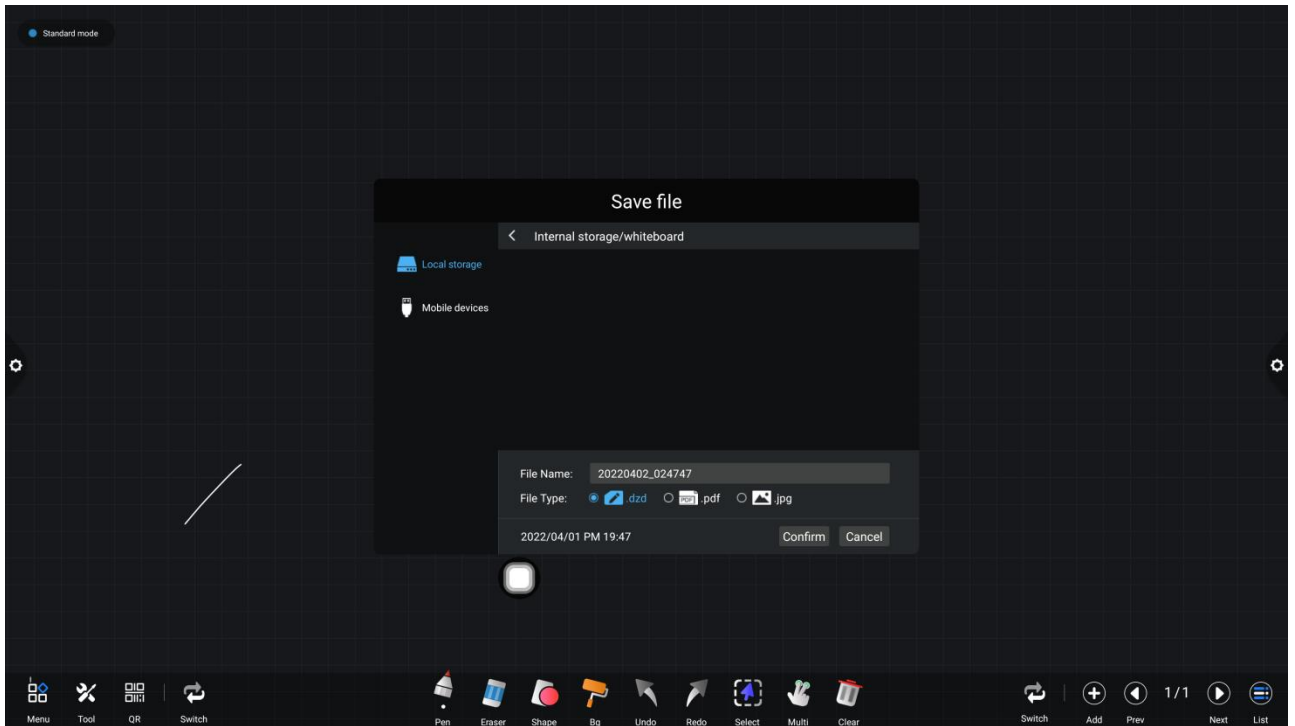

- (2) Save the file: Click  the icon to save the current writing content. The default time is named and saved. The user can customize the name to save. The user can select the built-in storage or U-disk to save the whiteboard file.



- (3) Export: Click  the icon to export the content written on the whiteboard in the image format \*. Jpg. The storage location of the exported image can be selected as built-in storage or USB flash disk.

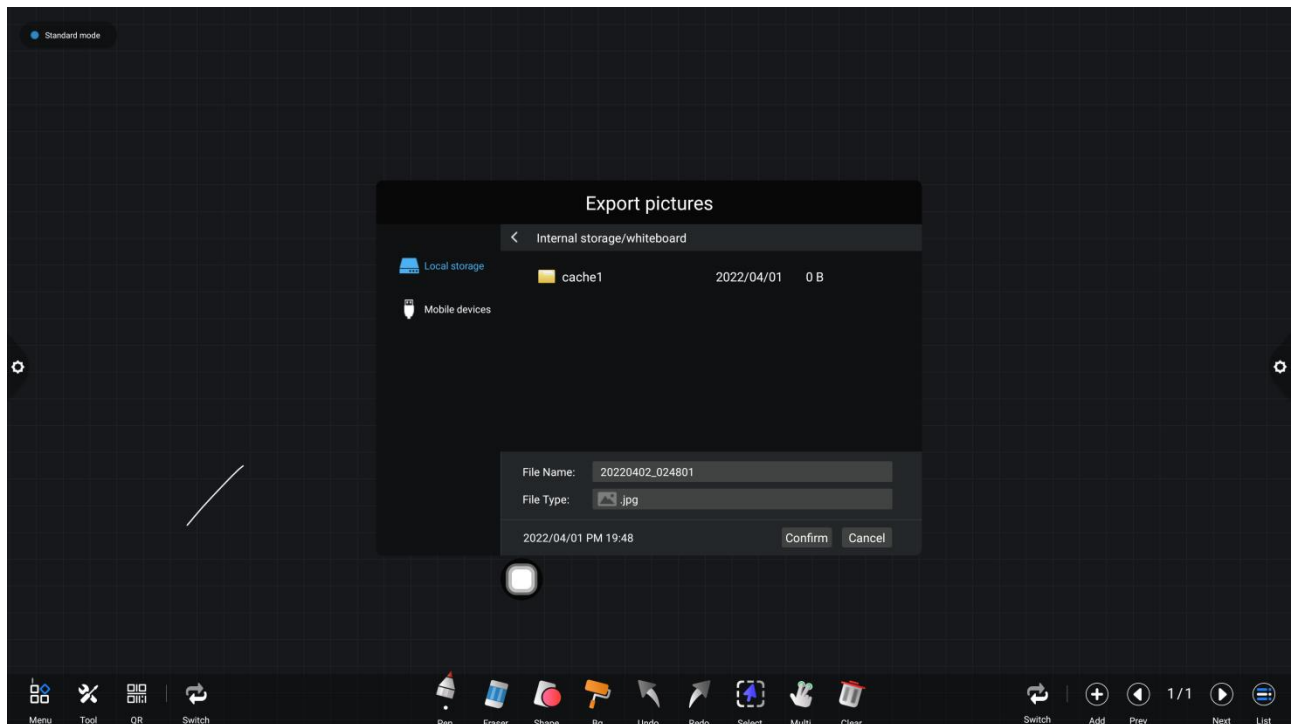

- (4) Insert: Click  the icon to open the local storage or U disk image file, the user can select the image to insert on the whiteboard, and the picture can be marked and written.

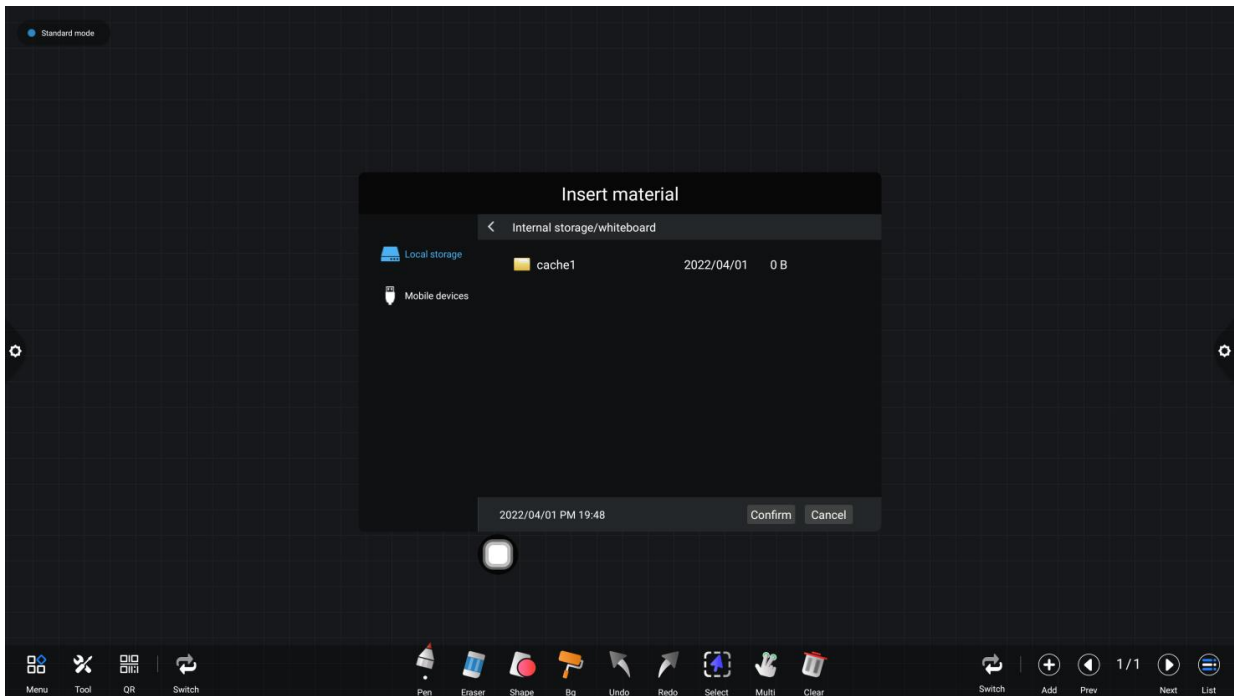

- (5) Email: Click  the icon. When using the email sending function for the first time, you need to set the email sender's email information in the email login interface, as shown in the figure:

- a. Use Tencent enterprise email, enter the account number and password, and click login.

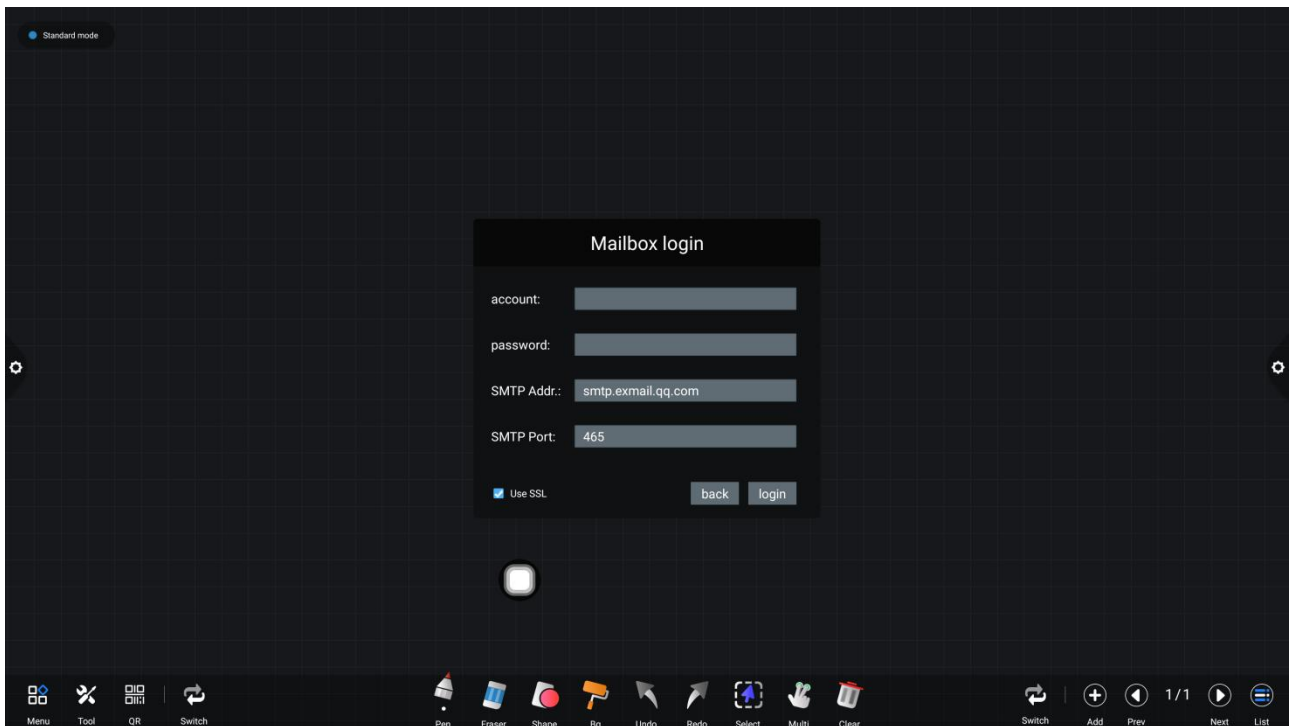

b. After successful login, the user enters the email address of the recipient, and then click send to record the contents on the whiteboard.

Pdf format file is sent to the recipient's mailbox, and click settings to modify and replace the current account number.

- (6) Click  the settings Icon to enter the network sharing settings and writing mode settings.
- a. Network sharing settings are divided into network sharing and local sharing functions.
  - b. The writing mode is divided into standard mode (single pen mode) and two-pen mode.
  - c. Other options are side write side wipe and finger wipe.

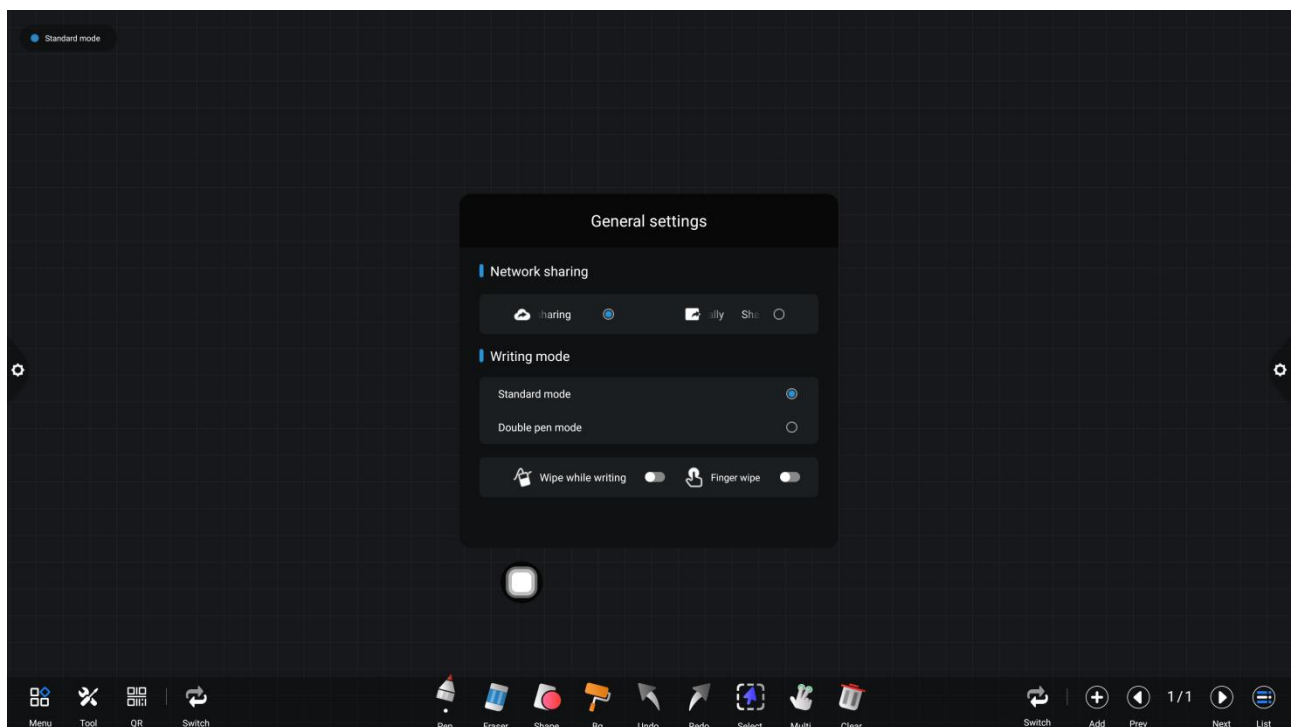

- (7) About: Click  the icon to view version information.

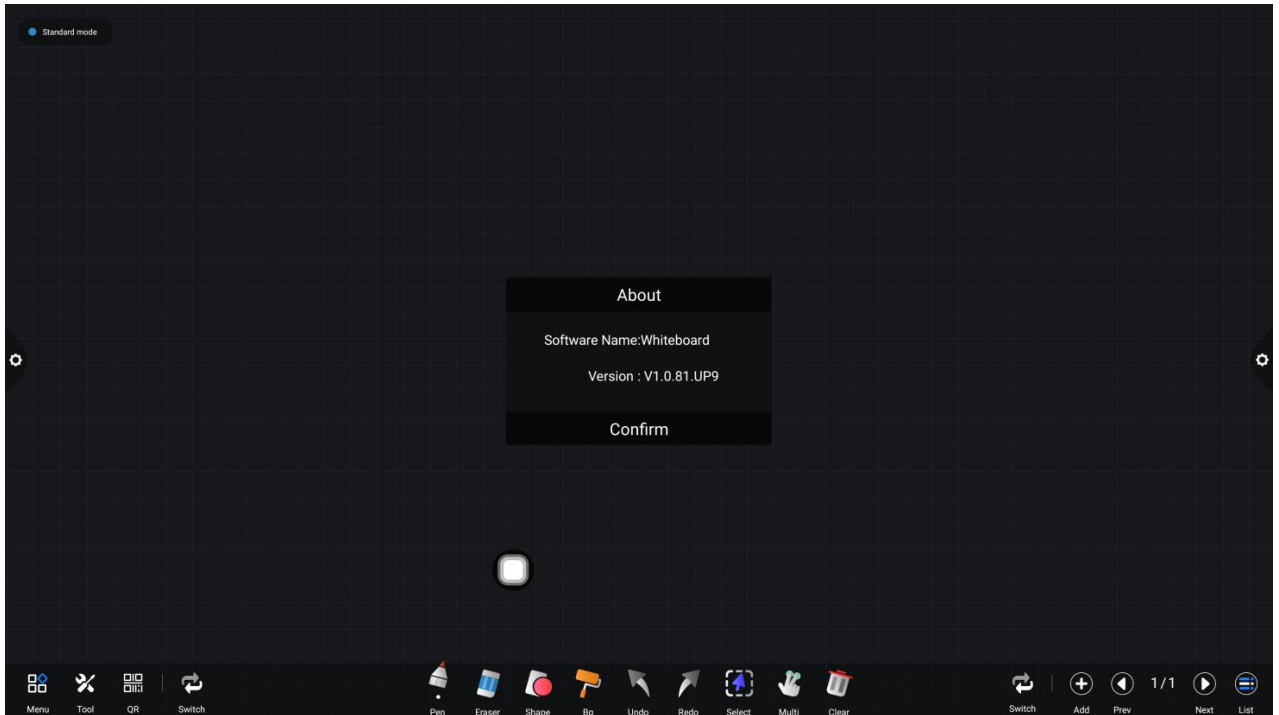

- (8) Exit: Click  the icon to exit the whiteboard when there is content on the whiteboard. A prompt will pop up: the whiteboard has not been saved. Do you want to save the whiteboard and exit the whiteboard. According to whether to operate the function or not; if the whiteboard has no content, click exit whiteboard.

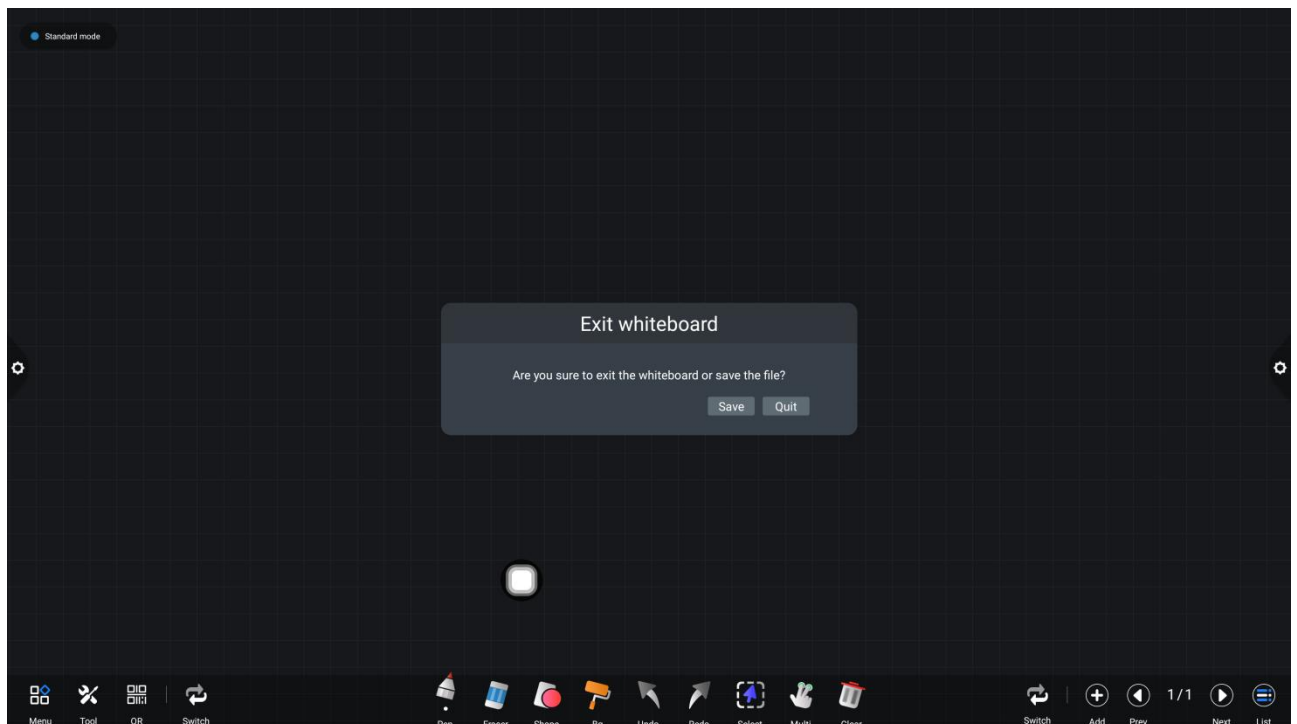

## 10.3 Aid tools

The system has its own ruler, compass, and can be inserted into the system's calendar, camera, screen, calculator, timer and spotlight gadget.

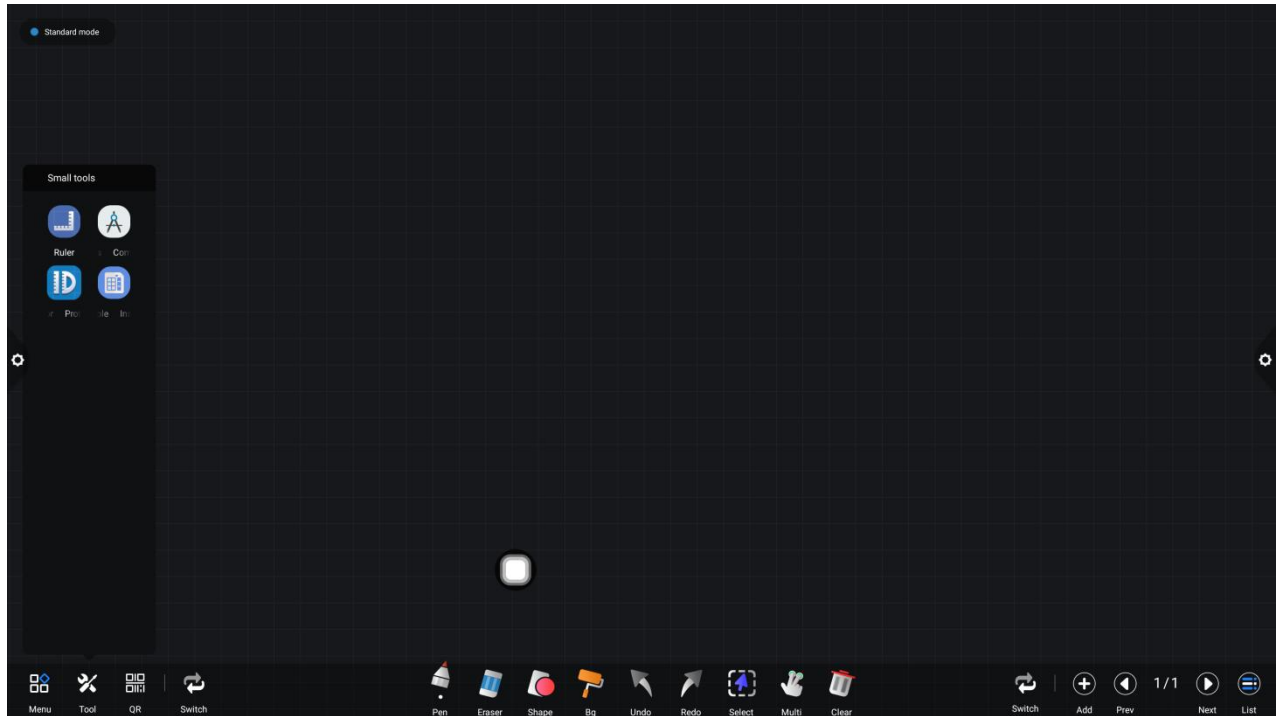

When the ruler is selected, the ruler tool appears on the screen, which can draw lines and mark the scale of lines.

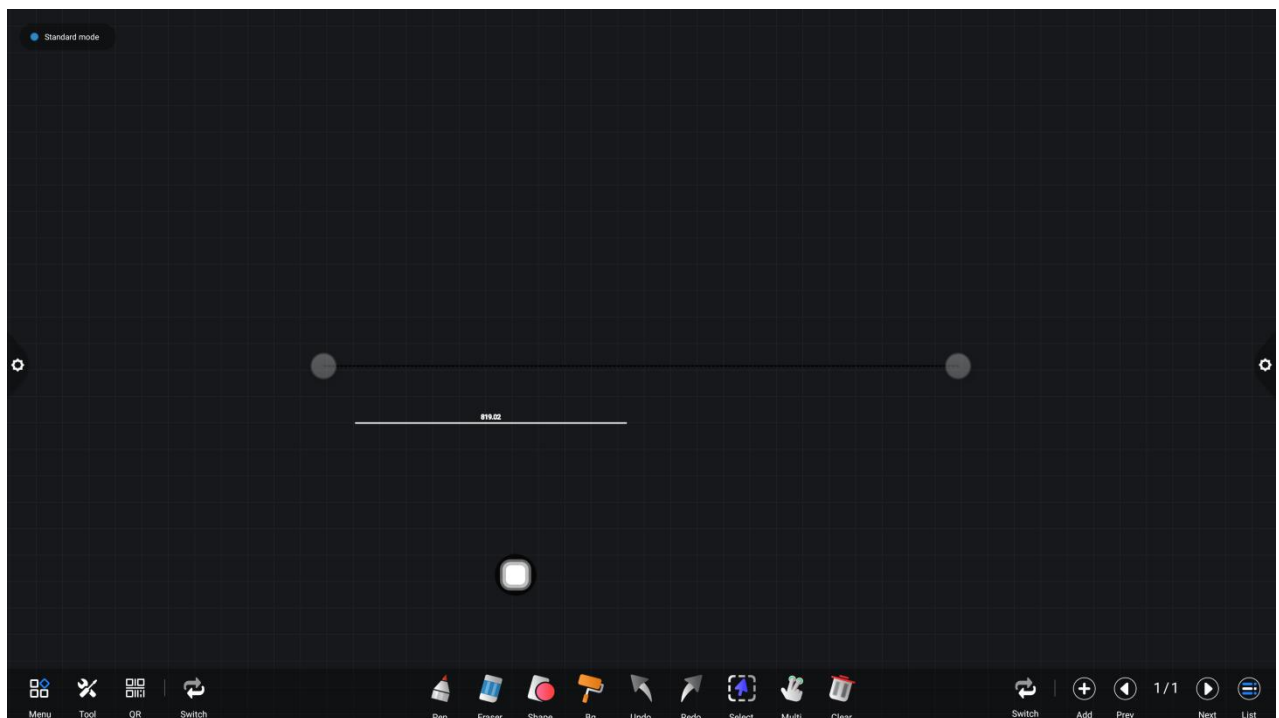

When you select a compass, you can draw circles or arcs on the screen.

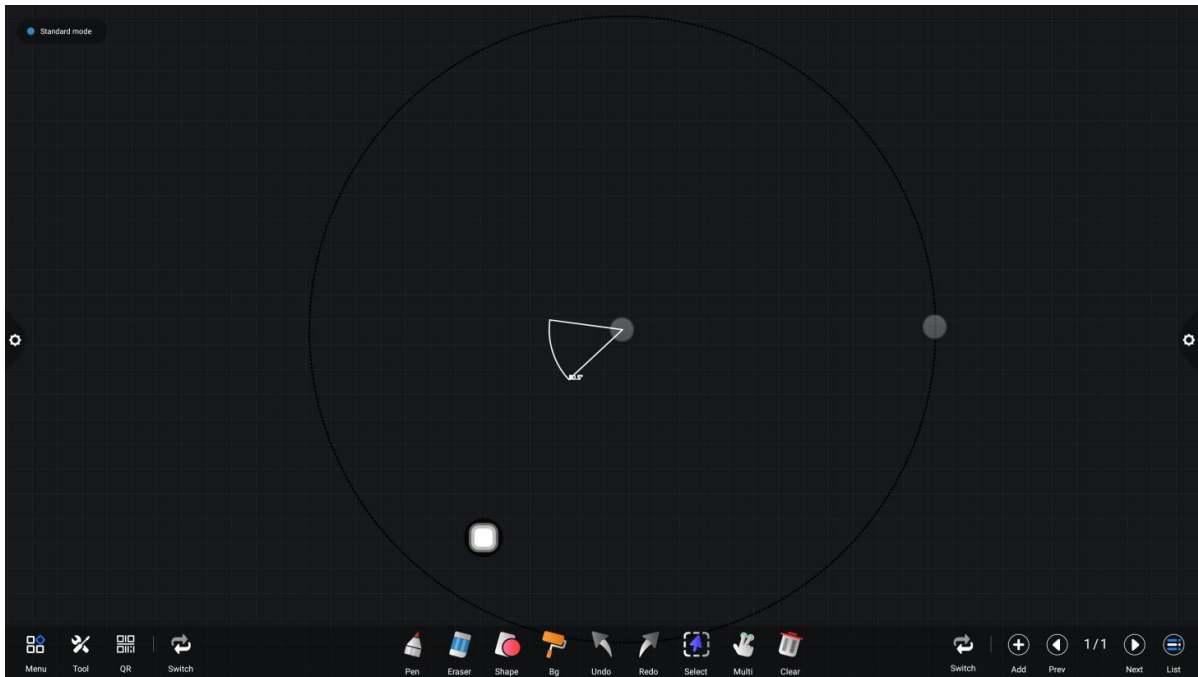

When selecting the calendar camera and other gadgets, the whiteboard application calls the application directly.

## 10.4 Scan code sharing

Code scanning and sharing: Click  the icon and select the sharing type. When the network is connected, a two-dimensional code window can be generated, and the current conference record can be swept away through the wechat scan function; if prompted, return to the home page, click to enter the system settings to connect to the network, and scan the code again after the connection is successful.

QR code sharing is divided into current page sharing and all sharing.

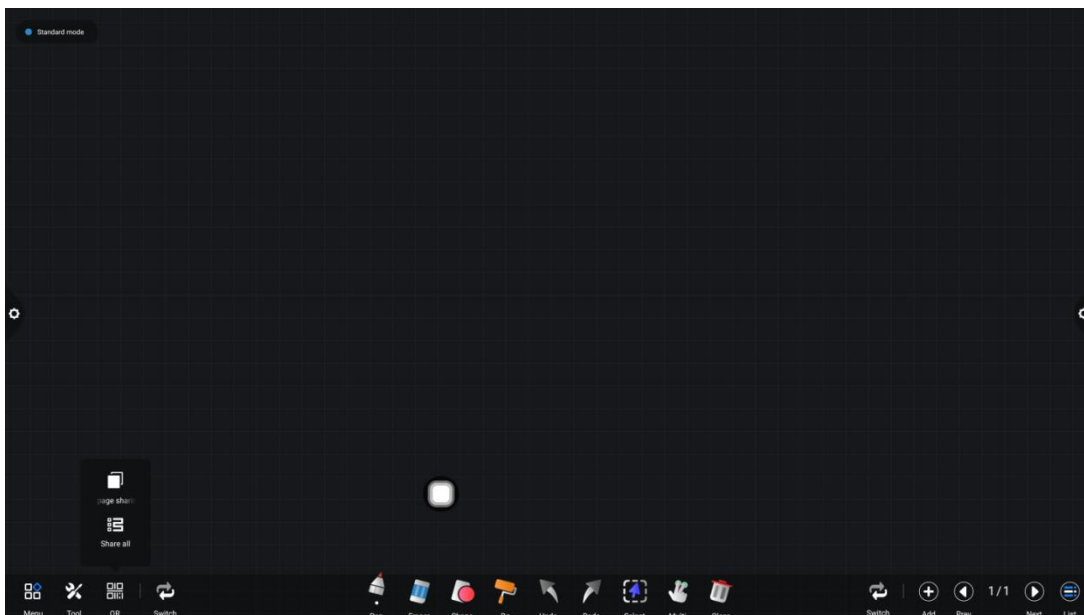

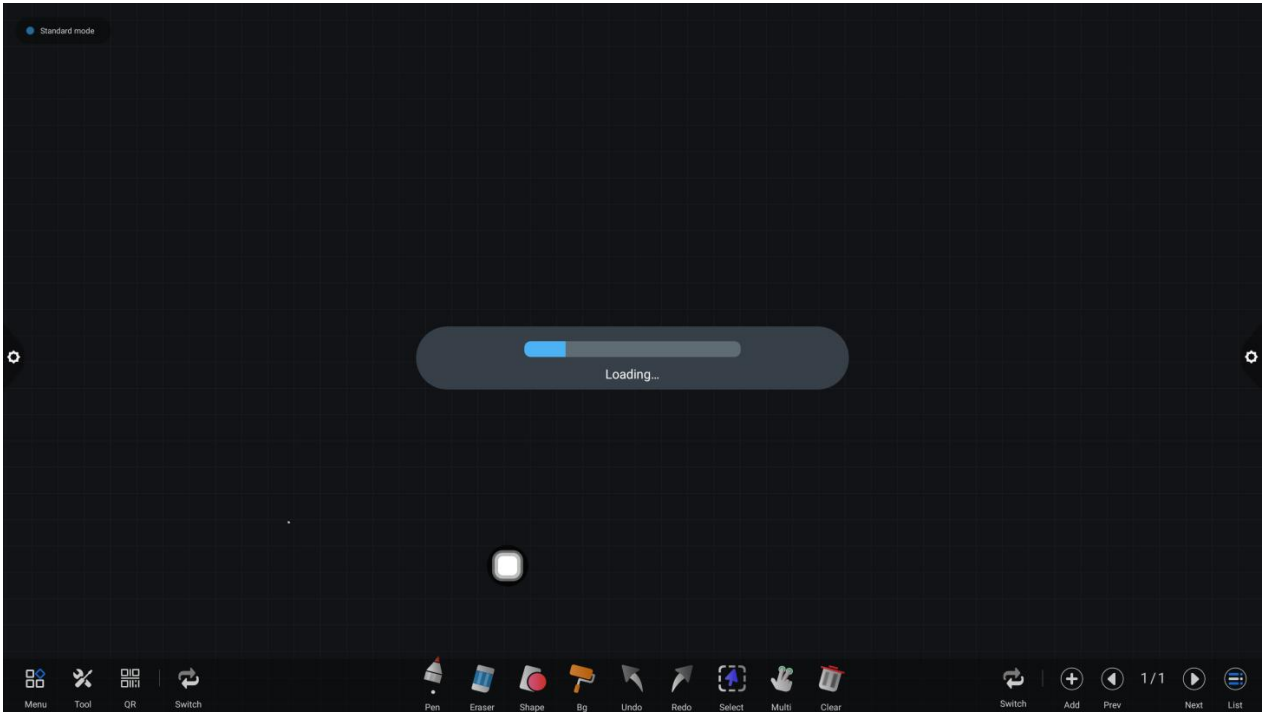

After the QR code is generated, the display is shown in the following figure. Click the lock icon to start the QR code lock mode, and the password is displayed next to it. After scanning the QR code, you must input the password before you can view the file.

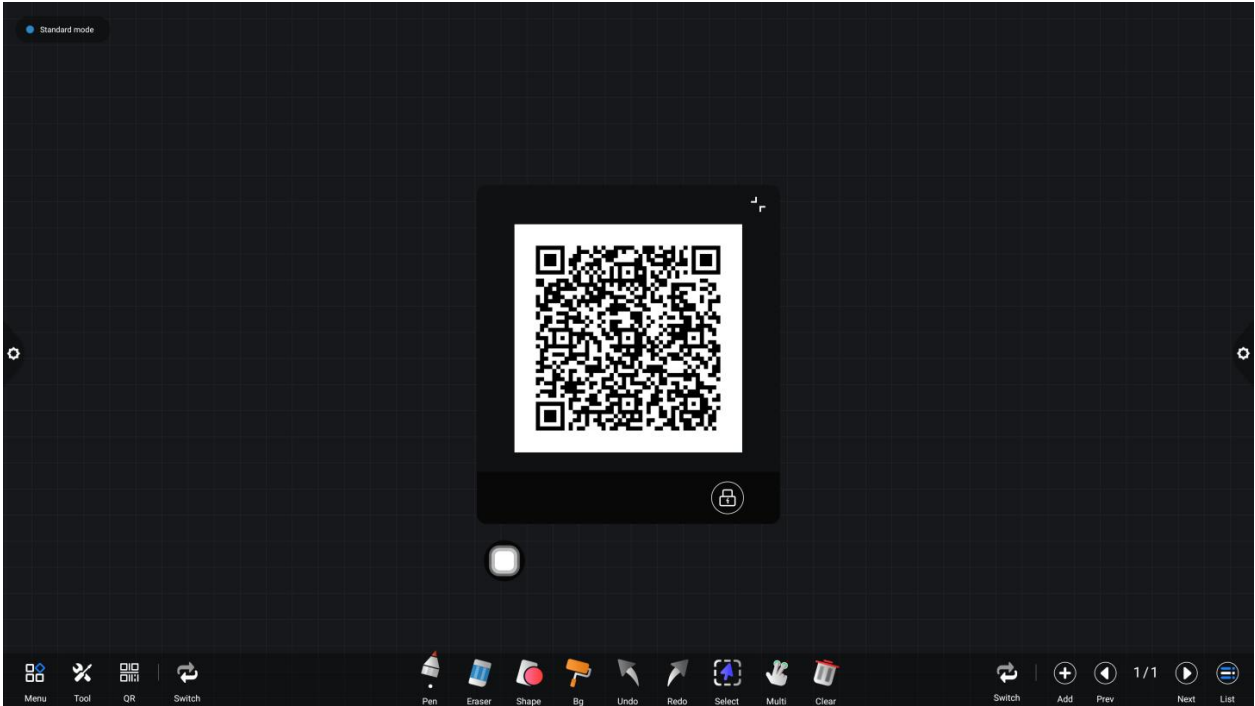

## 10.5 Common Function



### Brush tools

- (1) Click  the icon to call up the brush tools menu.
- (2) Change brush thickness and color.

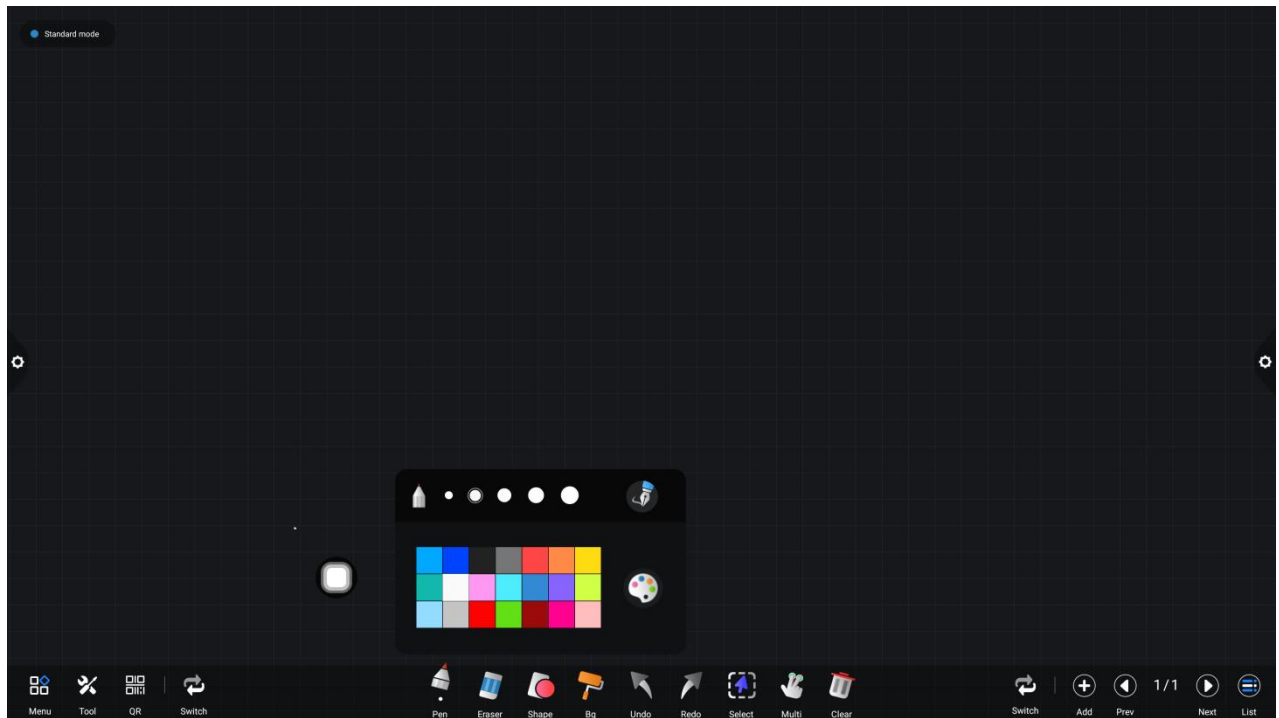
Click the dot icon above to modify the stroke thickness, click the color box to select the brush color, and click the custom icon to expand the color palette to customize the brush color.



### Eraser

- (1) Click wipe: Click  the icon to erase the written content;
- (2) Circle erase: Click  the icon to erase the handwriting in the area within the circle.

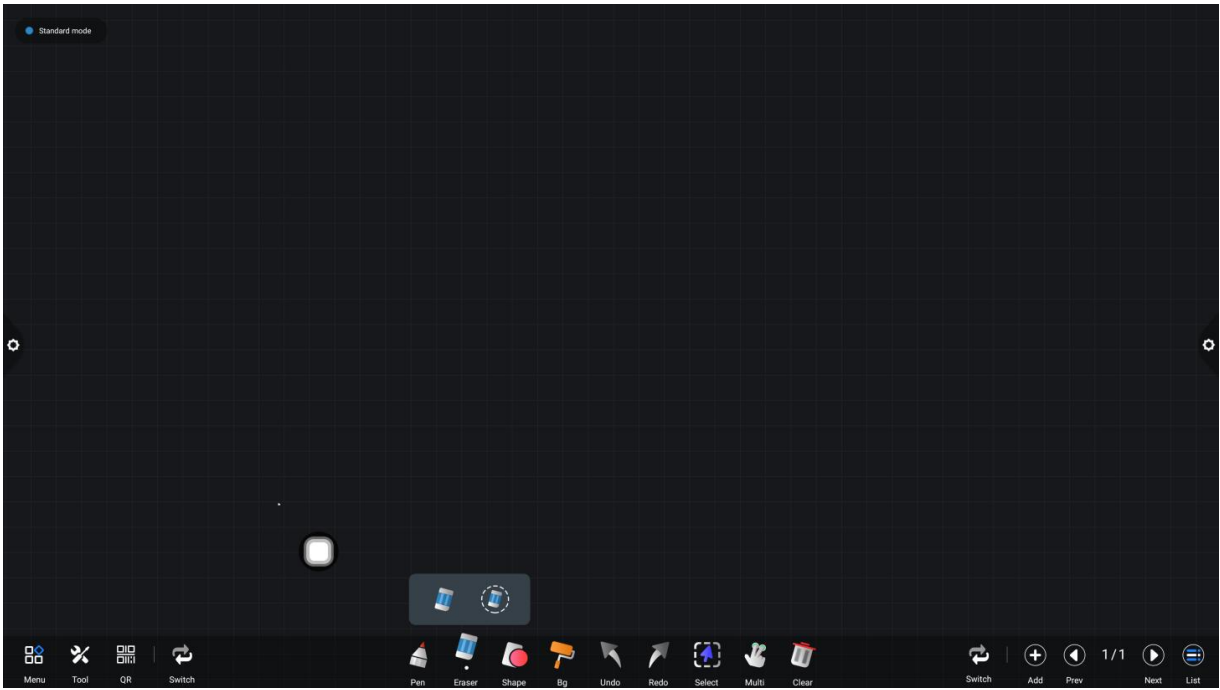

## Shape

Click to , pop up the graphic and image selection box. When the selected graph is drawn on the screen, it will be displayed as the corresponding figure.

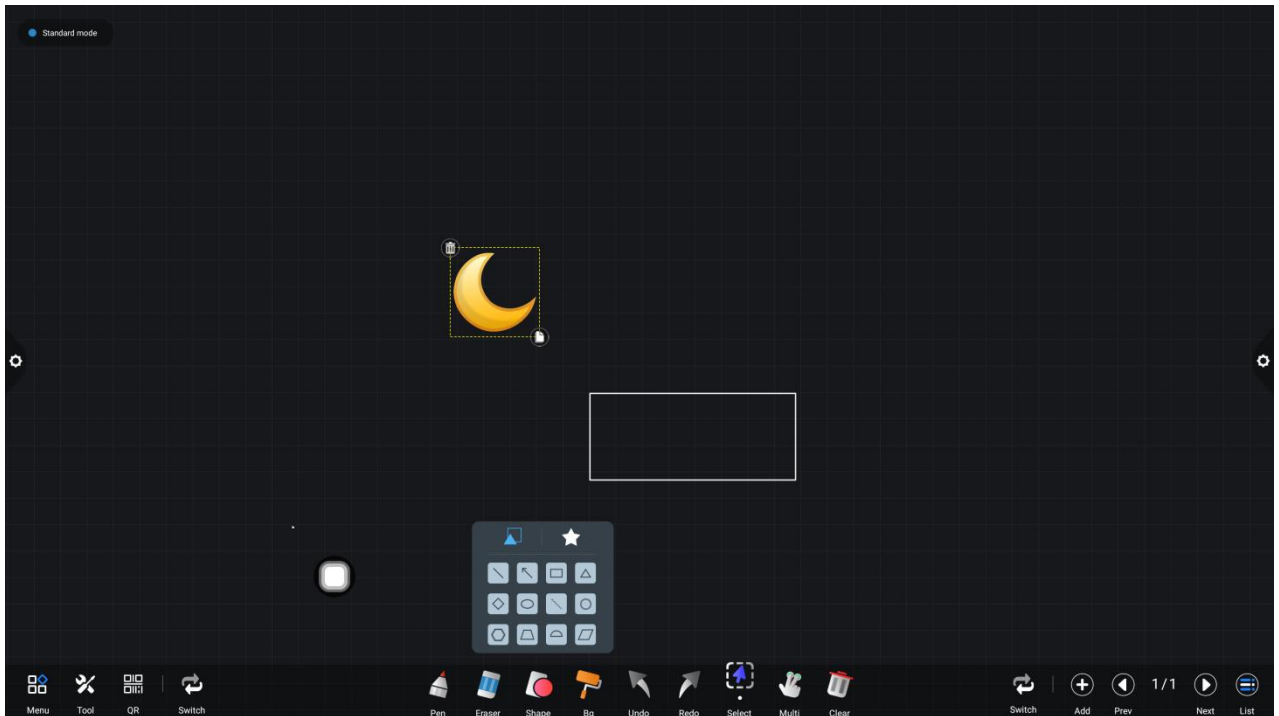

Click on the picture to insert the picture you just clicked on the screen.

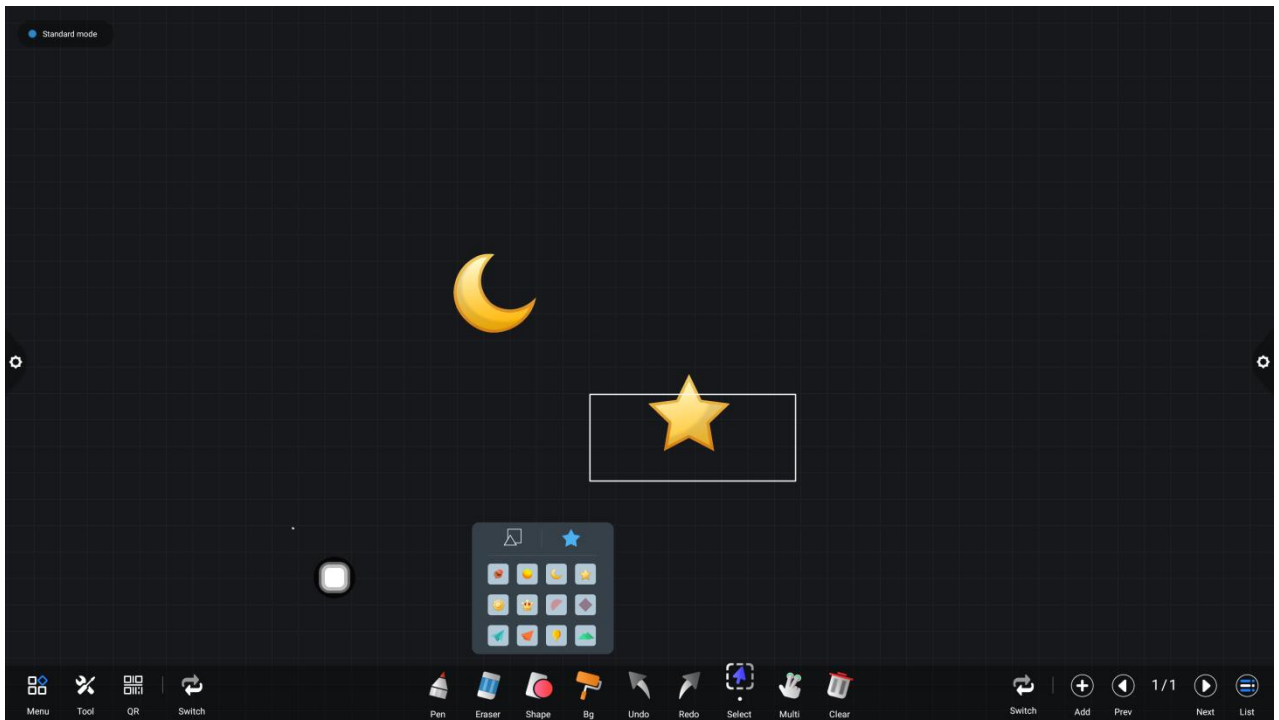

## Background

- (1) Click  to change the background color of whiteboard.

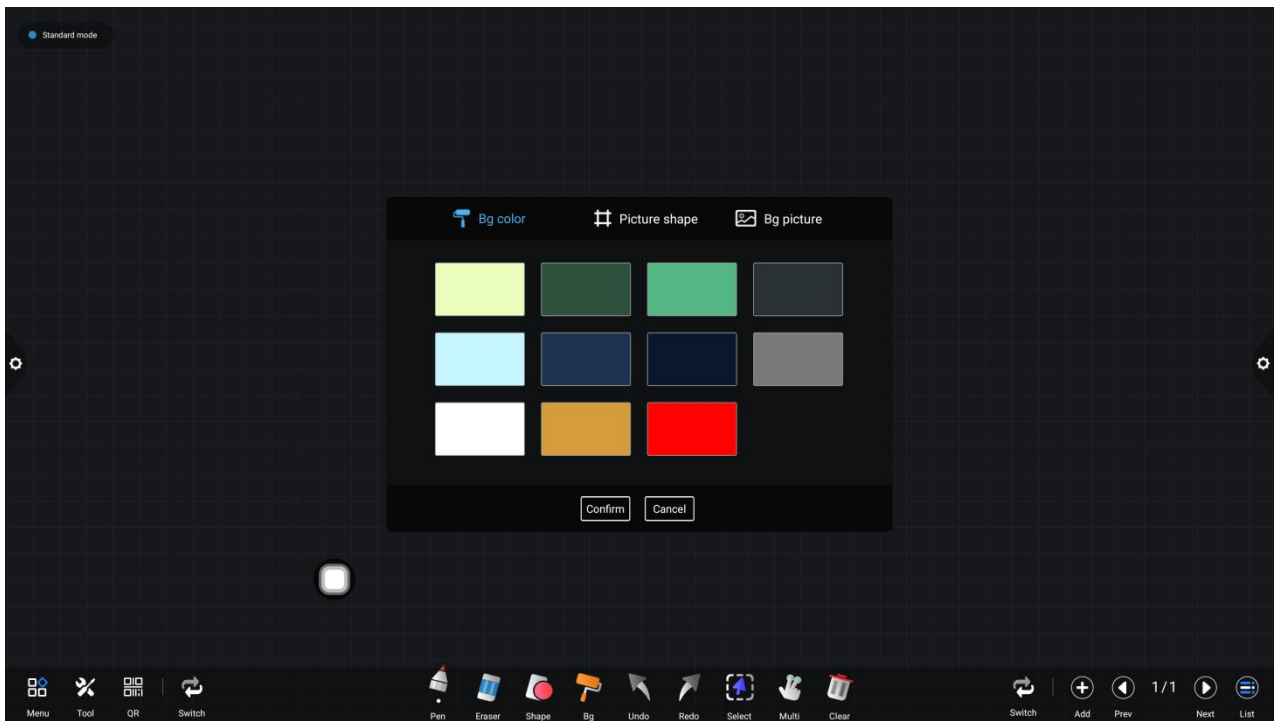

- (2) Picture shape

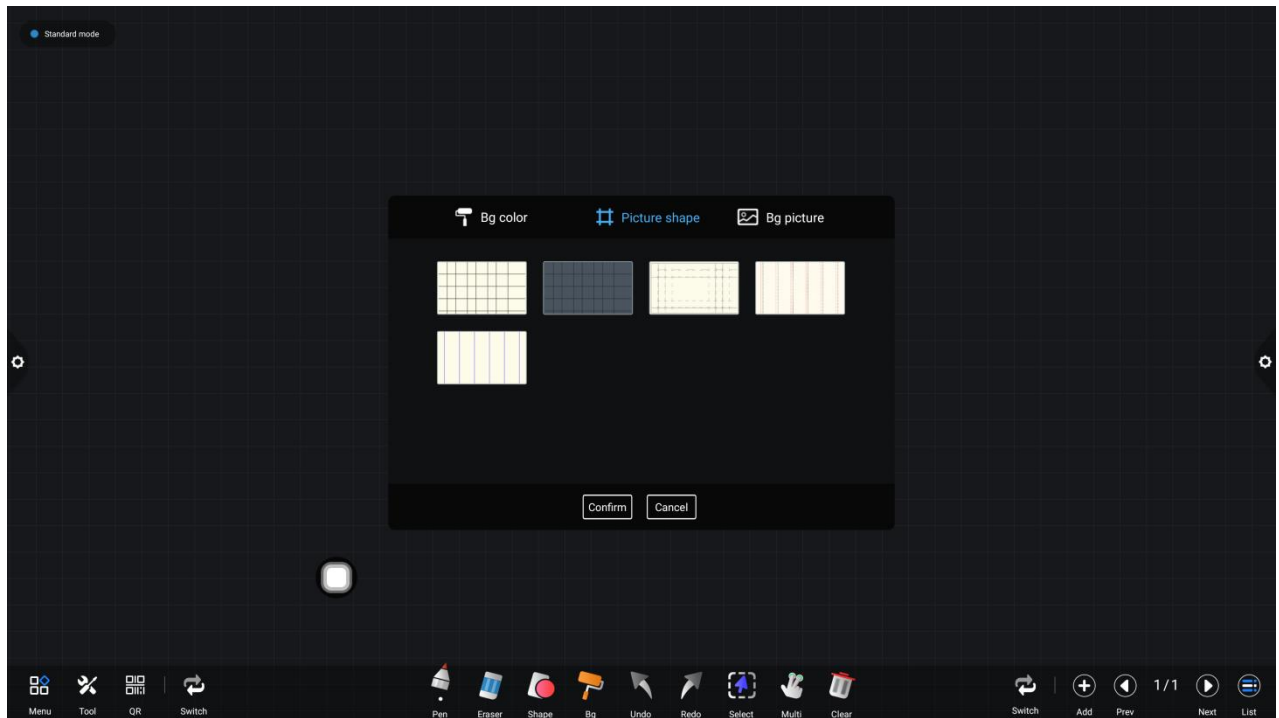

(3) Background image

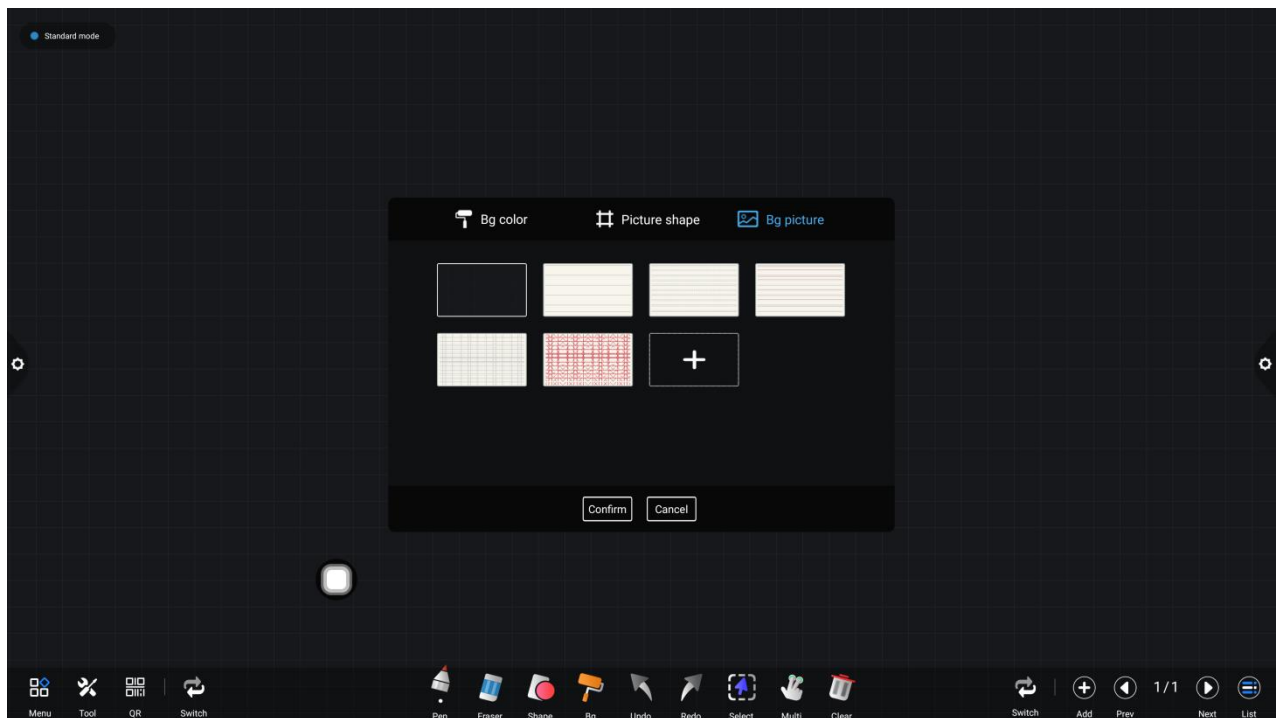

### Revocation and restoration

(1) Undo:  icon to undo the previous operation. At most 50 steps can be undone at a time;



(2) Restore: Click  the icon to redo the operation that has been revoked. The maximum recovery steps are 50 steps at a time.

## Select function

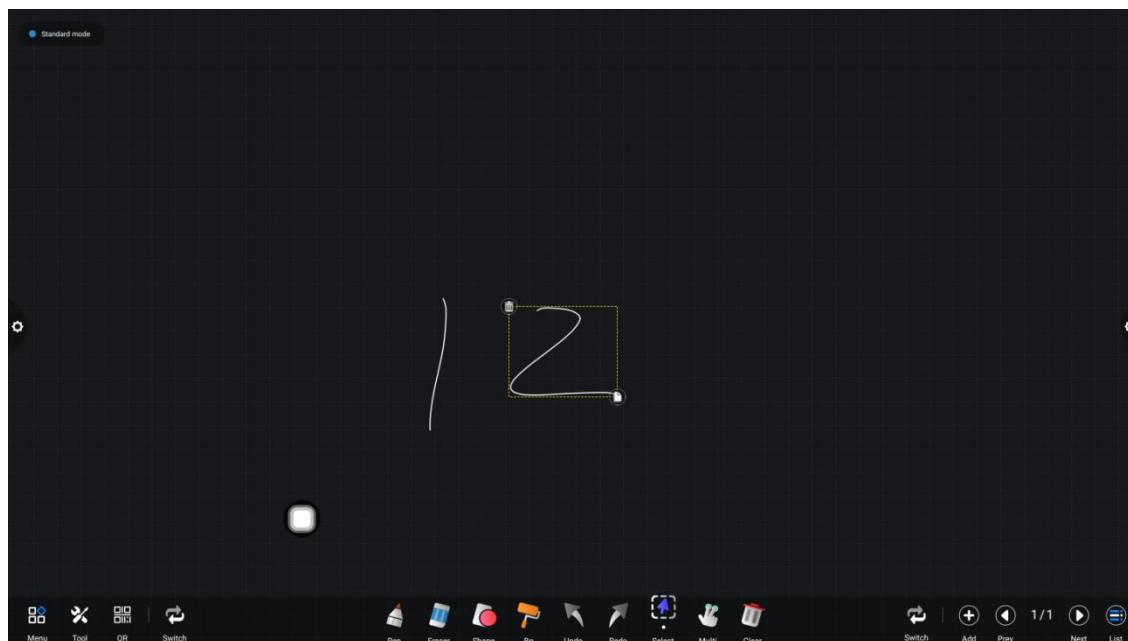
Click  to select the selection function, and the interface switches from writing mode to selection mode. The handwriting and shape in the interface can be drawn, and then the functions of moving, deleting, copying and pasting can be realized for the inserted pictures. Move, delete, copy and paste, rotate and zoom.



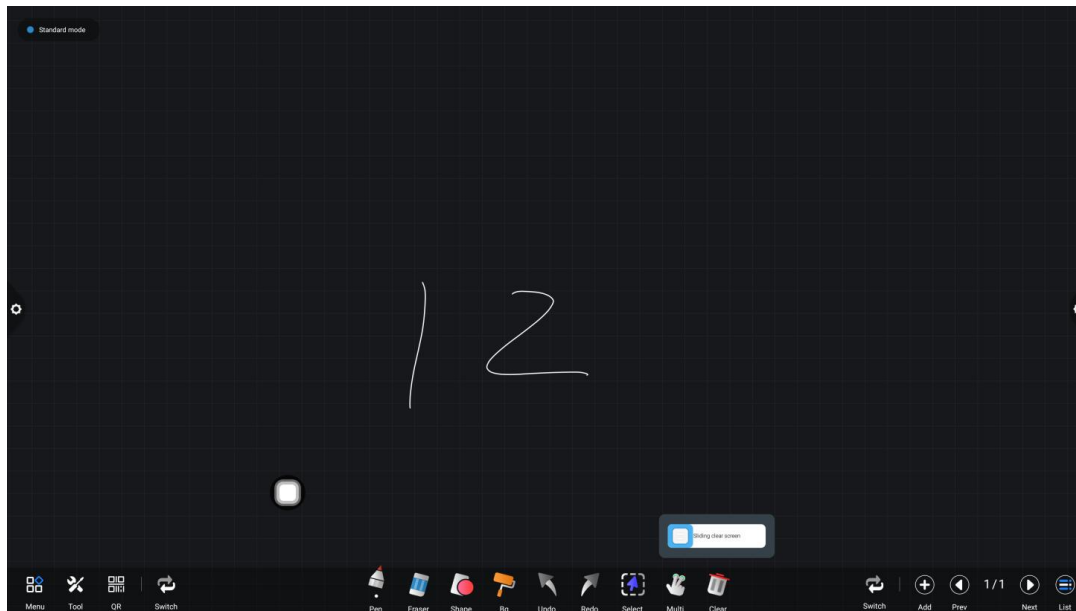

## Slide screen cleaning function

Click  the icon to call up the slider , and manually slide the icon  to the right to clear the writing content on the current screen.



### Left and right switching function



Click  the icon to switch the left and right positions of more function icons, code scanning and switching function icons  with the function icons on the upper and lower pages, page preview function icons  and page adding function icons.

### Page preview

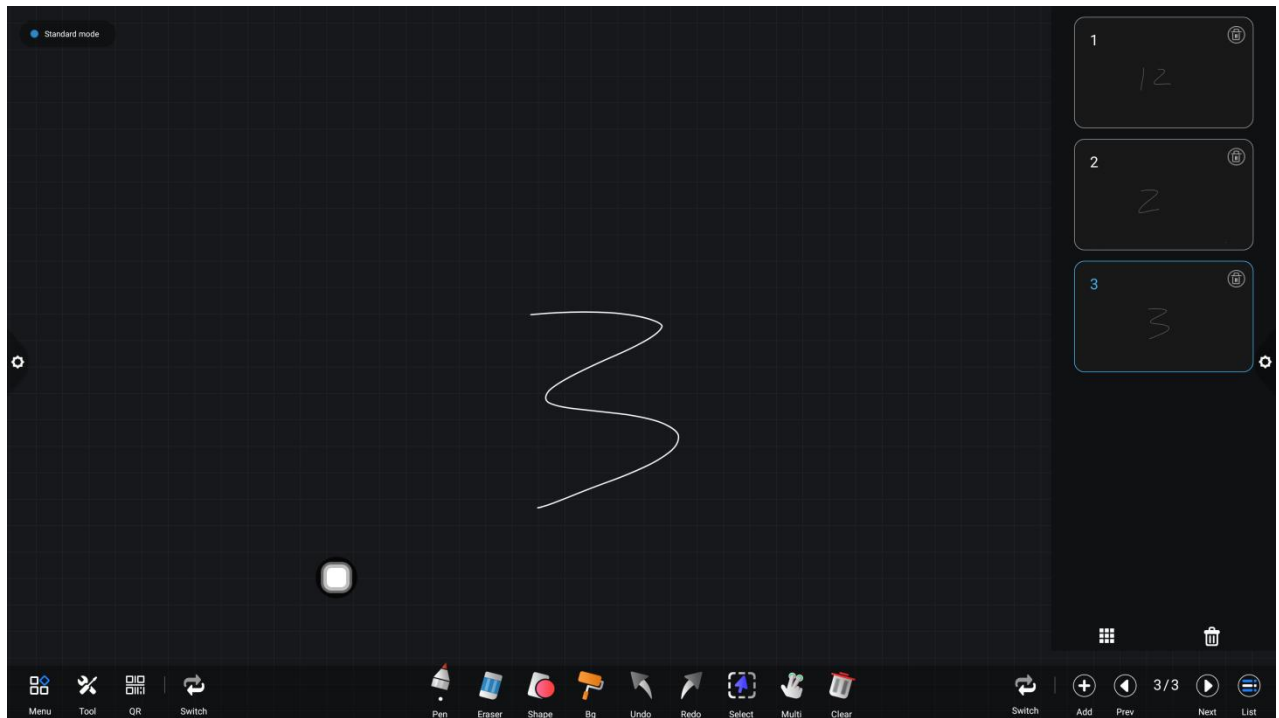
(1) Open the page preview pop-up window: Click  to show that the current page is selected.



(2) Add page: Click  the icon to add a page.

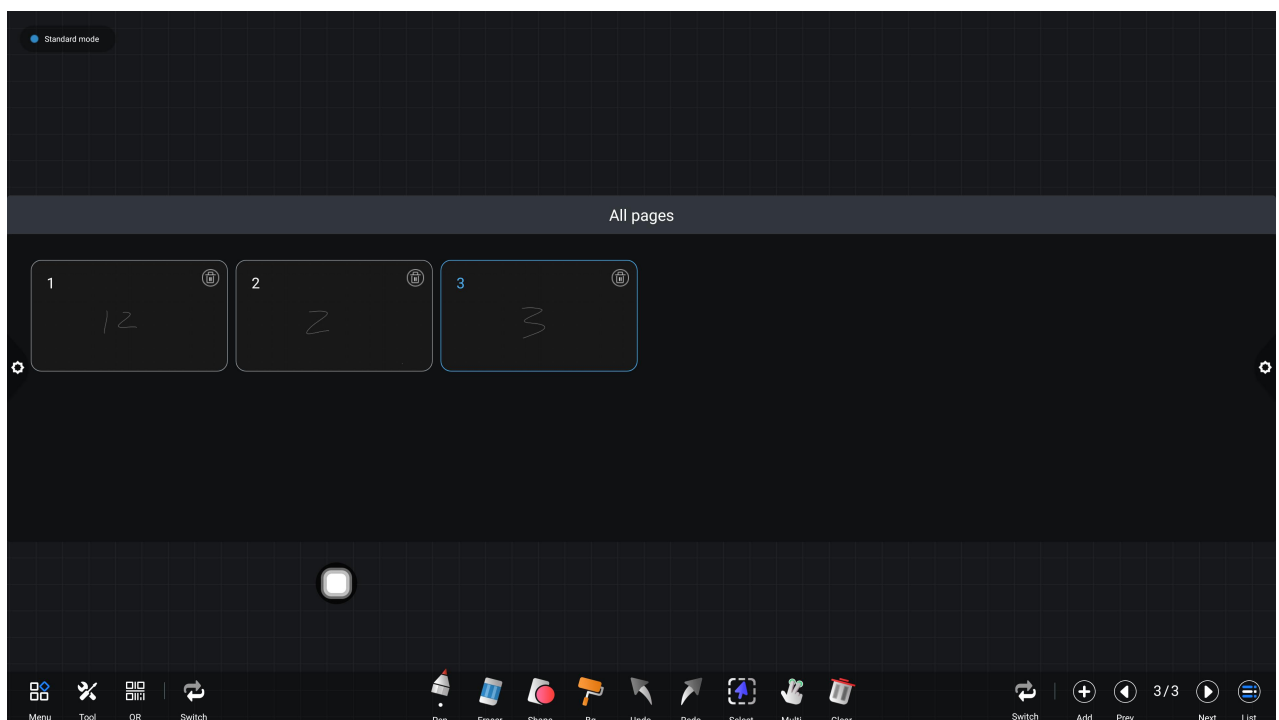

(3) Delete page: In the open page preview window, click  the delete button in the upper right corner of the page thumbnail to delete the page or click  at the bottom of the page preview window to delete all pages. to Click  enter all page display mode.

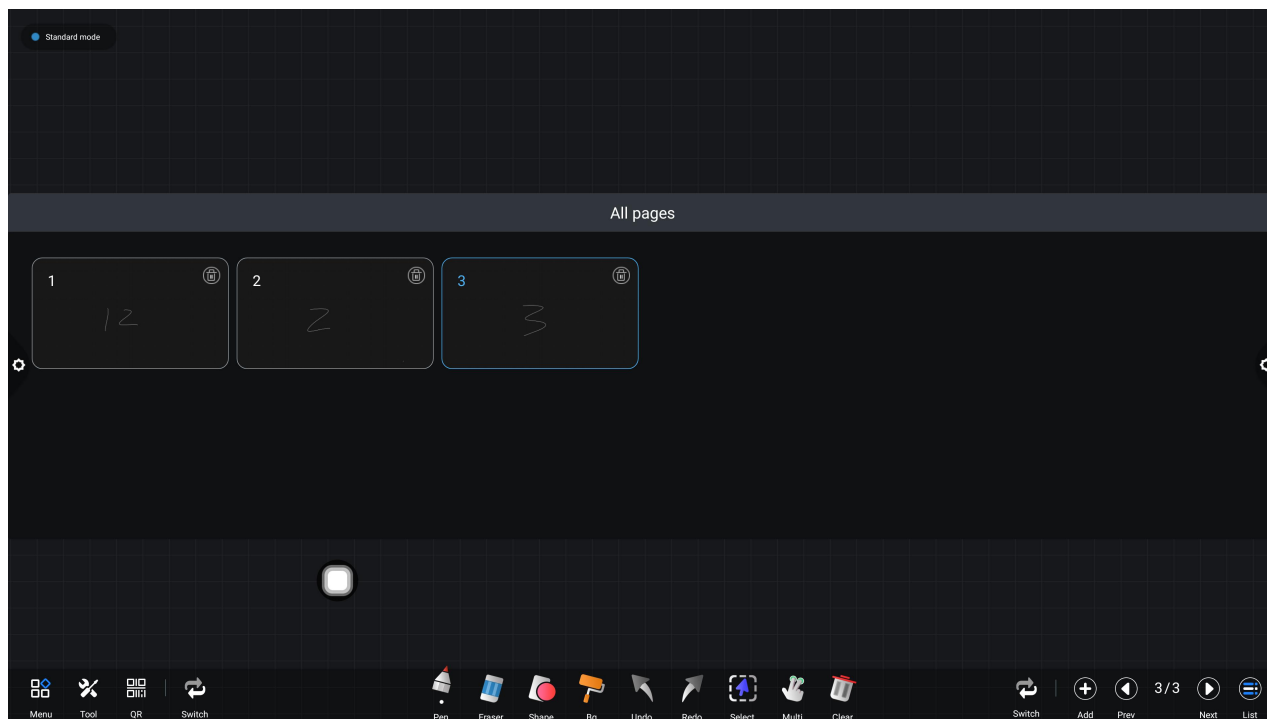

Delete page or delete at the bottom of page preview window, press to delete all pages. Click

 icon to enter all page display mode.



(4) Page turning function: Click the left  and right  page turning button and icon to realize page turning effect. In the page preview window, if the preview page exceeds the Limited Preview range, slide up and down quickly;

Click  to select to achieve page up and down function.

## 11. Screen Share

### 11.1 Application note

The main function of this application is to wirelessly transmit the content of mobile phones, tablets or computers to the display, and truly achieve the wireless screen transmission function of the projection device and the projected device (note: mobile phones, tablets or computers need to be on the same local area network).

### 11.2 Operating instructions



1. Click  (Screen Share) icon to open the multi-screen interaction interface, and the application display interface is as shown.

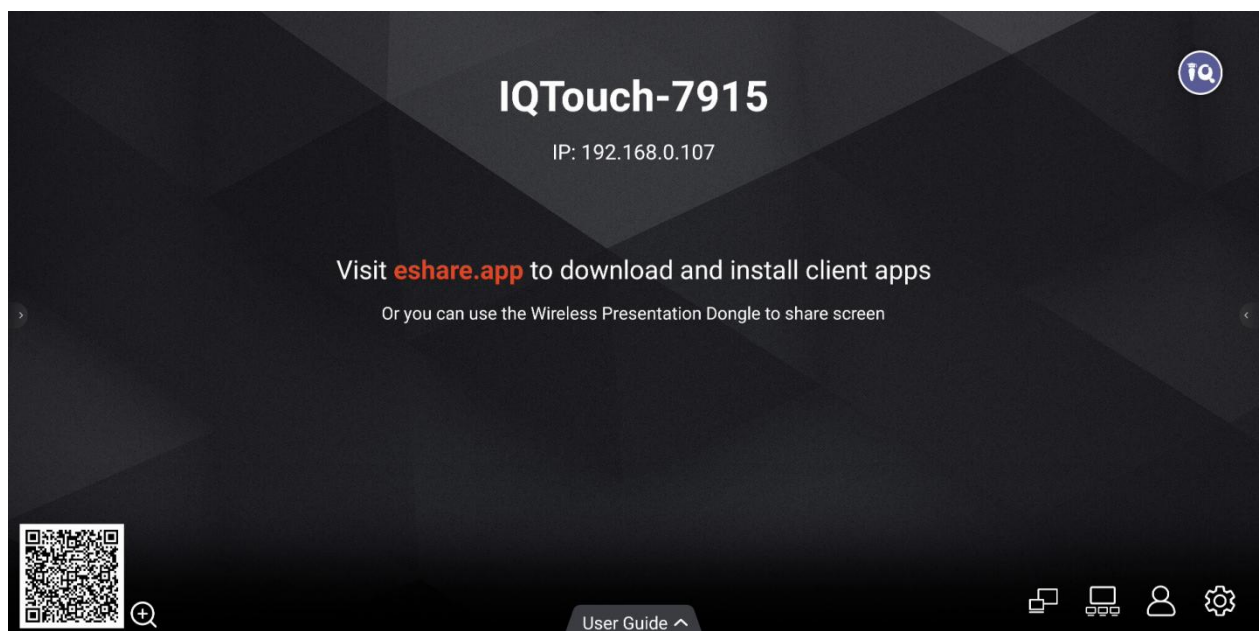

## 2. Function activation

Activate it only through connecting network if you have purchased EShare serial number.

## 3. Operating description

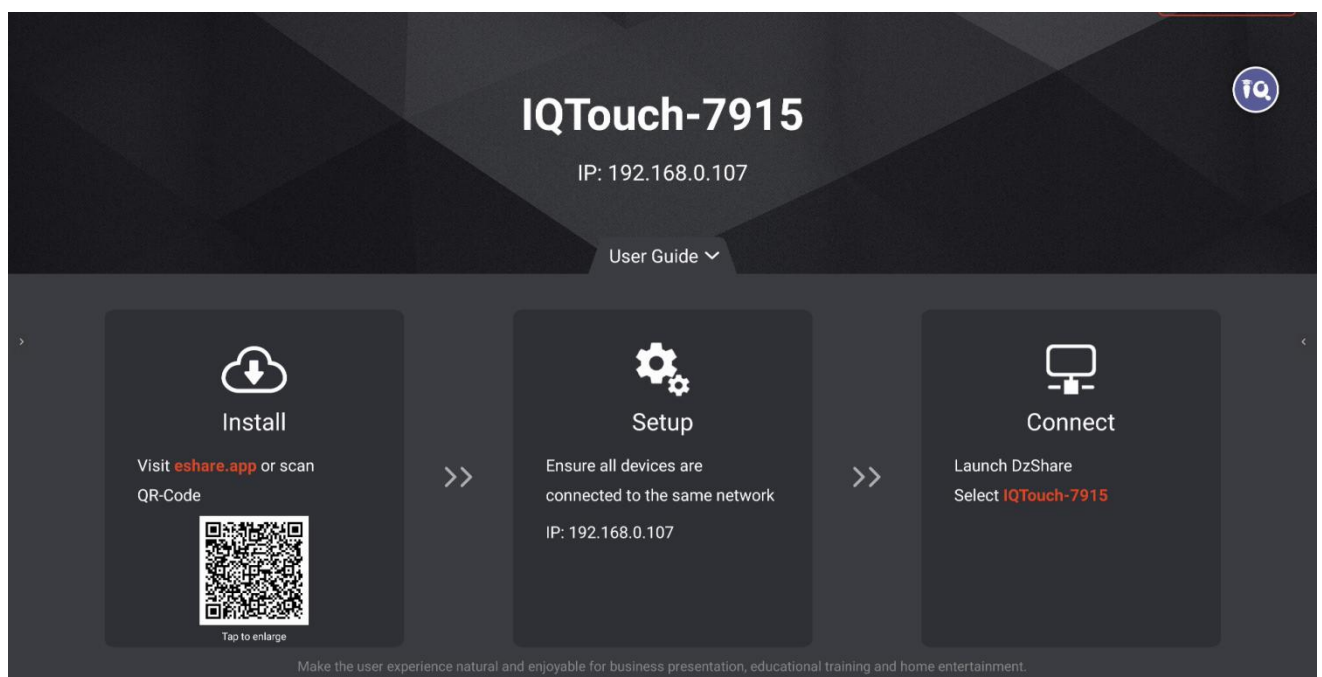

- 1) Android mobile phone connection network, scan the multi-screen interactive interface QR code to download and install E-share application software (Apple mobile phone does not need to download);
- 2) The mobile phone needs to use the same network as the all-in-one. The Android mobile phone can open the E-share to cast the screen, and the Apple mobile phone can open the Air Play to cast the screen.

### 11.3 Special instructions for multi-screen interaction interface

#### Device name

Click  icon, user can modify the device name

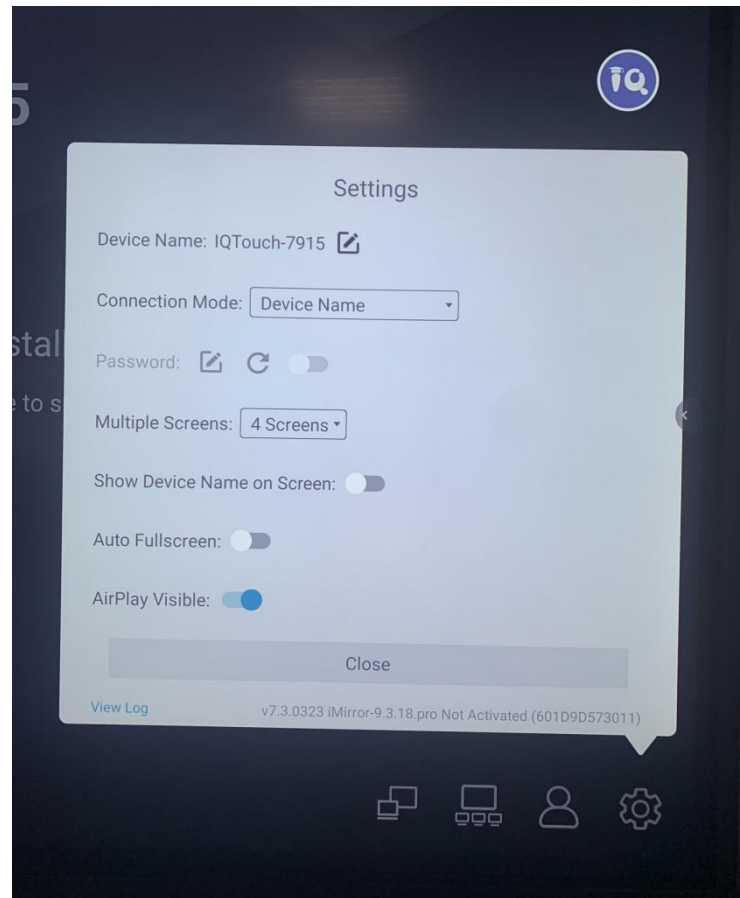

In this interface, you can modify the device name and set the connection password. when an Android phone connects to touch screen, it needs to enter the connection password to connect to the screen.

Multi-split screen: set the number of split screens

Show Device Name on Screen: the device name is displayed on the screen when it is turned on

Airplay visible: Airplay visible when it turned on.

## 11.4 Webcast remote screen sharing

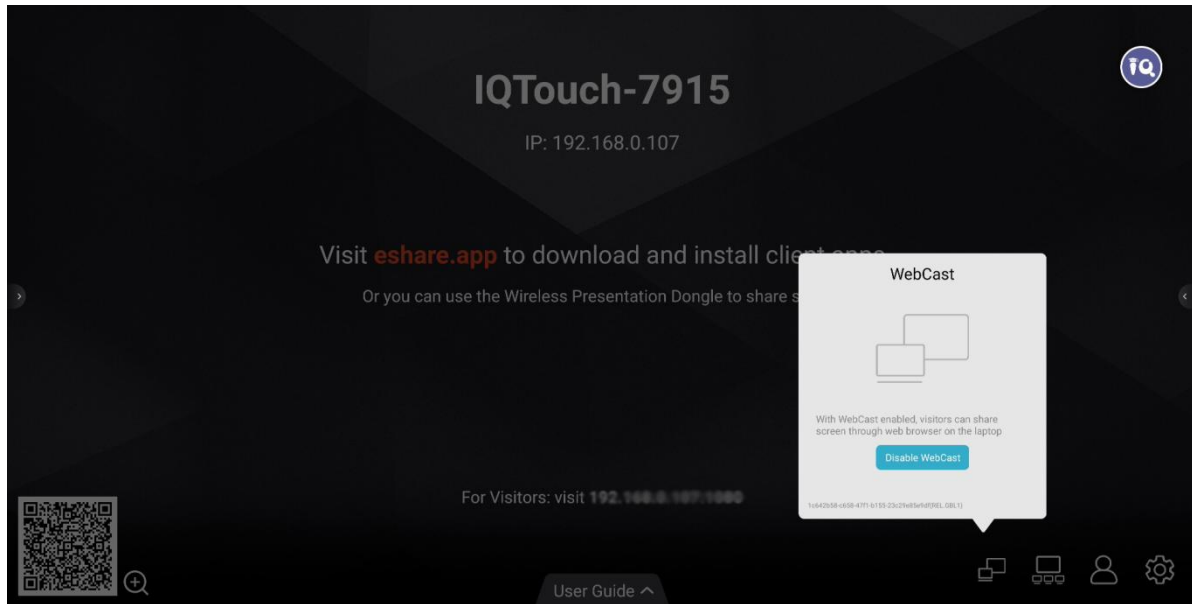

- Click Enable Webcast to obtain the IP address for visitor on the center place of the current page. Open browser and input the IP address to share your personal screen from different places with no requirement of the same LAN.
- Click Disable Webcast to exit remote screen share.

## 11.5 Laptop screen sharing

The screen sharing of the laptop needs to be used with the IQShare button. The IQShare button is as shown below:

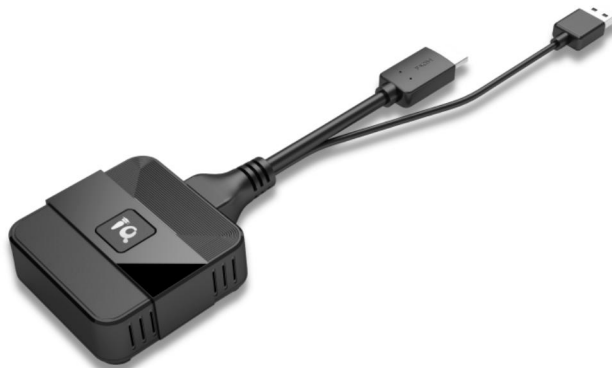

Note: Before using the IQShare button wireless screen function, user needs to make sure that the hotspot of the Touch screen is turned on.

## **1. IQShare button should be paired with Touch screen**

The USB port of IQShare button should be inserted into Touch screen and paired with touch screen. The touch screen will display paired successfully after few seconds.

Note:

- A. A Touch screen can be paired with up to 8 IQShare buttons in the same network environment.
- B. Multi-screen function supports to connect up to 9 mobile devices and simultaneously display on 9 split screens.

## **2. Screen and laptop pairing**

### 1) Start pairing

Plug the IQShare button into the laptop's USB port and HDMI port and paired with the laptop. The indicator light of the IQShare button is always flashing blue and is being paired with the laptop.

### 2) Pairing completed

When the touch screen successfully connects to the laptop, the indicator light of the IQShare button will no longer flash blue.

### 3) Screen sharing

Press the button of IQShare button, the blue light will be dimmed, which means the screen sharing is successful, and the screen and sound of the laptop will be mirrored to the touch screen; press the button again, the screen mirror will exit.

## 12. Built-in PC Operation

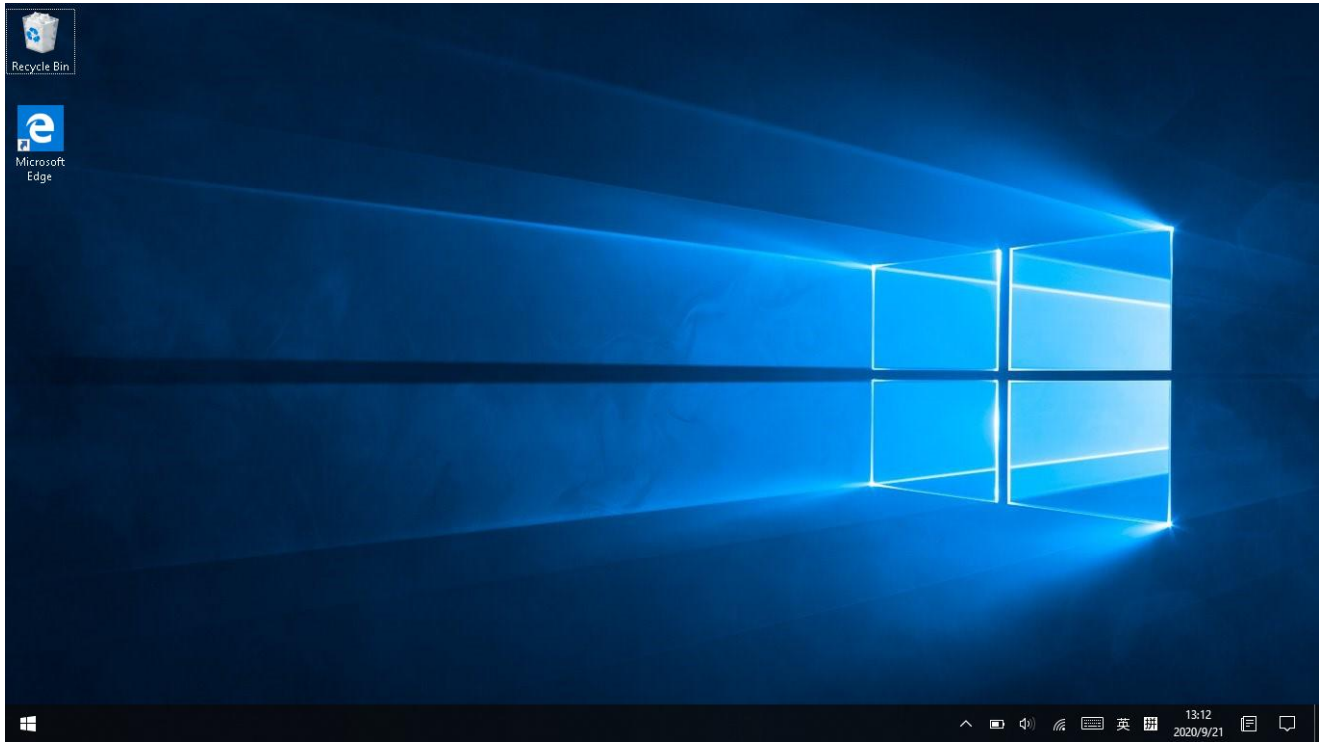

- 1) Select PC signal source to enter PC interface. The following are three ways to select a signal source channel.
  - Swipe your finger up from the left and right side to bring up a toolbar then click **input**.
  - Press **INPUT** button on the remote control.

In the signal source page, select a channel and press OK or click the channel icon directly to enter it.

- 2) Operate the built-in PC in the same way as you operate an ordinary computer.
- 3) Shut down PC before you turn off the panel. Do not power off a running PC suddenly to avoid data lose. Or you could also press Power button to turn off PC and panel at the same time.

## 13. Troubleshooting

<b>Remote Control</b>	
Remote control out of order	<ul style="list-style-type: none"> <li>● Check whether there is object between remote control and panel receiver;</li> <li>● Check whether the battery is installed correctly;</li> <li>● Check whether the battery is drained.</li> </ul>
<b>Touch</b>	
Touch does not response.	<ul style="list-style-type: none"> <li>● Make sure infrared frames have not been obscured.</li> <li>● Check whether you enable freeze function on remote control.</li> </ul>
<b>Built-in PC</b>	
OPS shut down automatically.	<ul style="list-style-type: none"> <li>● Check if OPS is properly installed;</li> <li>● Sleeping mode setting;</li> </ul>
<b>Handwriting</b>	
Part of the handwriting cannot be displayed.	<ul style="list-style-type: none"> <li>● Use the pen rather than a finger to write. Hold the pen as far to the nib as possible. The angle between the pen and display needs to be greater than 60 degrees. Do not touch the display with your sleeve or wrist.</li> <li>● Change the nib or use a pen with larger covering area.</li> <li>● Check if infrared frames are obscured.</li> <li>● Remove the interference source or change the using environment.</li> </ul>
<b>No display or no sound</b>	
No sound is played and no image is displayed.	<ul style="list-style-type: none"> <li>● Check whether the power plug is inserted into the power socket and whether the panel is powered on.</li> <li>● Check whether the rocker switch on the interactive flat panel display is switched on.</li> <li>● Check whether panel is in ECO mode.</li> <li>● Check whether the video and audio input cables are connected correctly.</li> <li>● Check whether the panel is switched to the right signal source.</li> <li>● Check the settings on image brightness and contrast.</li> <li>● Check the volume.</li> </ul>
Image is displayed properly, but no sound is played.	<ul style="list-style-type: none"> <li>● Check the volume.</li> <li>● Check whether the Mute button on the remote control is pressed.</li> <li>● Check whether the audio cable between the PC and interactive flat panel display is connected correctly.</li> </ul>
No image is displayed or the	<ul style="list-style-type: none"> <li>● Modify the color settings.</li> </ul>

image is black and white.

- Check the color system.

This is the general user manual for all IQTouch TE1100Pro interactive flat panel display. Some details may be different from the actual product.



**STOCK CODE**  
**836453**



🏢 Returnstar Interactive Technology Group CO., LTD.  
📍 6th Bldg. High-Tech Base. Fuzhou Fujian Prov. China  
☎ 0086-591-38202660  
📠 0086-591-38203003  
🌐 [www.IQBoard.net](http://www.IQBoard.net)  
✉ [IQBoard@IQBoard.net](mailto:IQBoard@IQBoard.net)

© Returnstar Interactive Technology Group CO., LTD